

# WARMING TRENDS<sup>®</sup>

SUPERIOR FIRE FEATURE SYSTEMS

DEALER CATALOG

NOT FOR DISTRIBUTION. AUTHORIZED USE ONLY.



**PATENTED**

[www.warming-trends.com/patents](http://www.warming-trends.com/patents)



# WARMING TRENDS<sup>®</sup>

Superior Design. Superior Performance.  
Superior Fire Feature Systems.



Standard Ring Burner with 180K BTU's

Don't settle for less.

---



CFB180 CROSSFIRE® Brass Burner with  
180k BTU's

The patented CROSSFIRE® Brass Burner is the most fuel efficient burner in the industry,  
producing beautiful, tall, bright flames all while consuming less gas.

100% Brass. Lifetime Warranty. Made in the United States.

# SIX STEPS TO FIRE!

- ① Measure the interior dimension of your fire pit.
- ② Choose the corresponding Plate or Pan size. (Pans include a 2" welded sidewall).
- ③ Select Burner based on appropriate size and fuel type. (Natural Gas or Liquid Propane).
- ④ Choose the Ignition System: match lit or a fully automatic ignition system.
- ⑤ Add Optional Electronic Accessories: remote control options, dial timers, and emergency stop buttons.
- ⑥ Complete the fire pit with Media: steel or ceramic logs, lava rock, or fire glass.

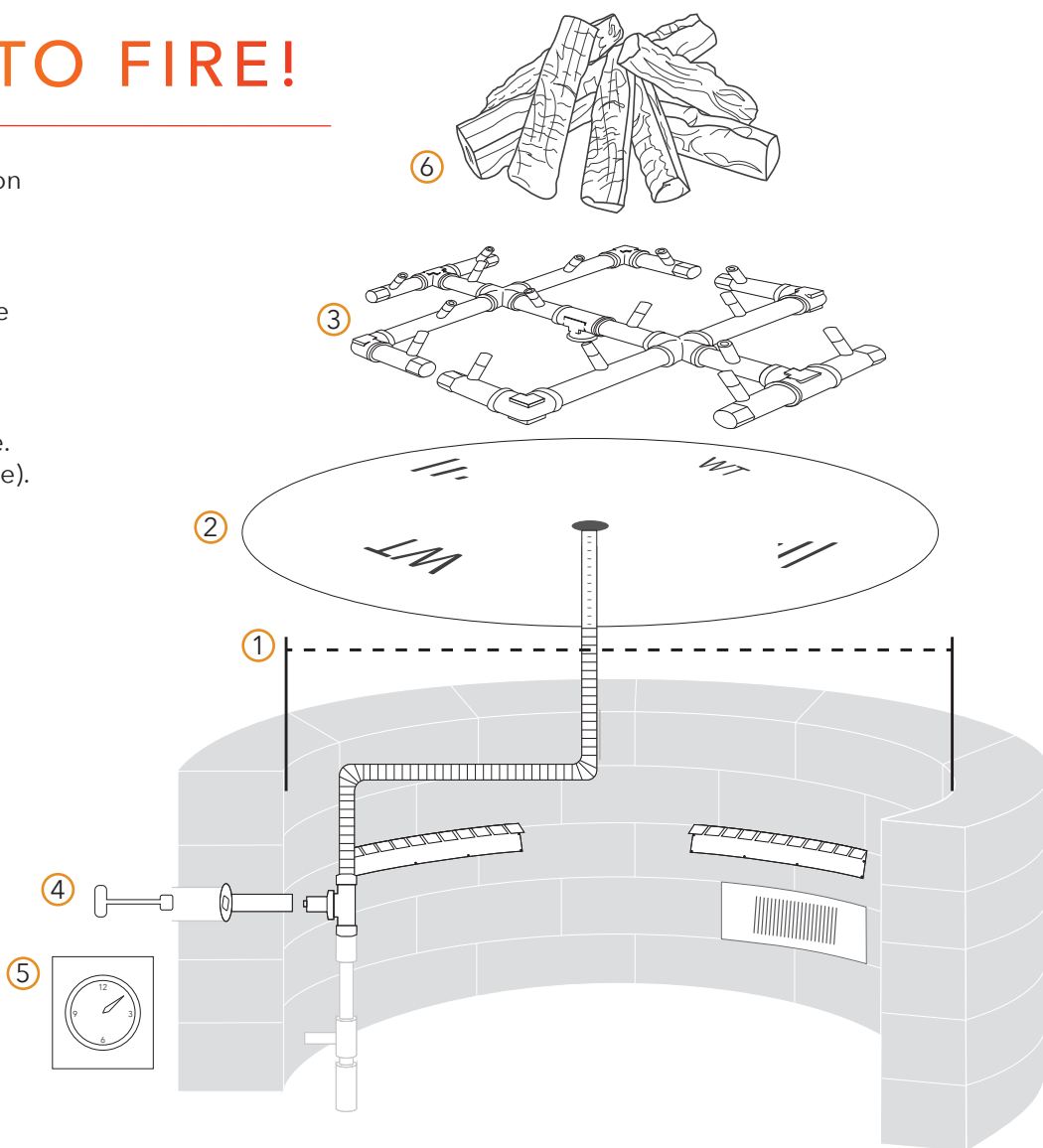

## PLEASE REMEMBER

- Plate should be sized slightly smaller than the measurement of the opening. This allows easier insertion and, if needed, removal for service.
- For outdoor use only. Installation and service must be performed by a qualified installer, service agency, or gas supplier. Installation and use must follow all local codes.
- Manufacturer recommends 3" of clearance from all interior sides of enclosure to nearest jet to avoid damage to enclosure.
- Modification of product will void any certification and warranty. (See page 69 for warranty information.)
- Follow all installation instructions and local codes. A copy of the Owner's Guide and Instruction Manual can be found on our website.

The Dealer Catalog is intended only for the possession and use of the Distribution Partners of Warming Trends and contains confidential information not meant to be disclosed to others, including competitors. Sharing, duplicating or distributing the Dealer Catalog is prohibited to anyone other than Dealers, Distributors or others authorized in writing by Warming Trends®. Our Distribution Partners may share prices or other information in the Dealer Catalog with customers as needed to enable individual sales.

Warming Trends maintains a Minimum Advertised Price (MAP) policy and it is strictly enforced with each of our selling partners.

For more information and resource materials, please visit our website. [www.Warming-Trends.com](http://www.Warming-Trends.com)

**PATENTED**  
www.warming-trends.com/patents



# TABLE OF CONTENTS

---

Reference Guides	6
Certified Burners	9
Options for Circular Openings	10
Options for Square Openings	20
Options for Rectangular Openings and Fireplaces	30
Custom Designs	19, 29
Plates and Pans	44
Ready-to-Finish Kits	50
Universal Paver Kits	56
Ignitions, Parts, Accessories & Media	60
Warranty	69

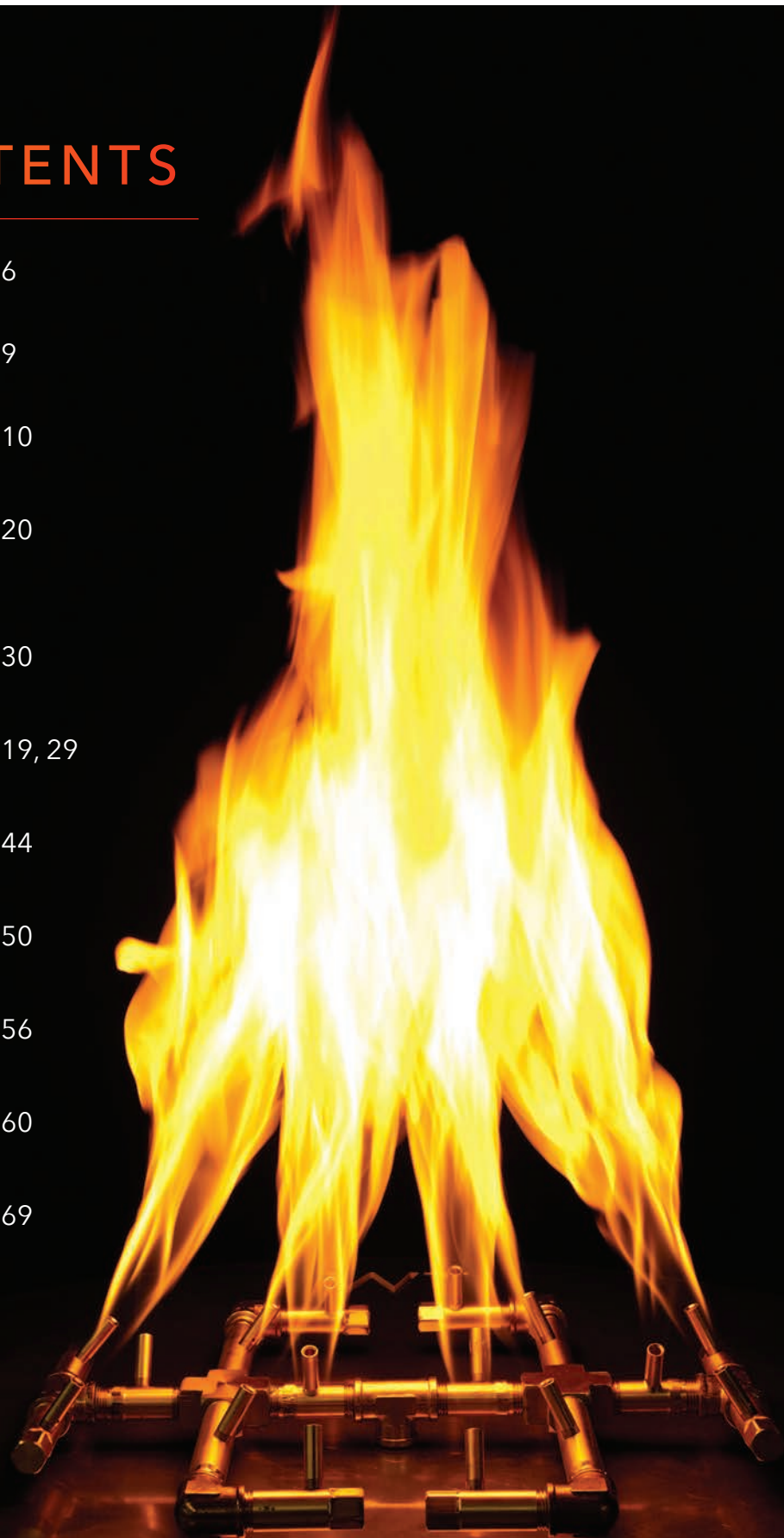

877 556 5255

[orders@warming-trends.com](mailto:orders@warming-trends.com)

[www.Warming-Trends.com](http://www.Warming-Trends.com)

# QUICK REFERENCE GUIDES

If you have a standard-sized fire feature or are planning to retrofit a Warming Trends® burner into an existing fire pit, the list below will help you determine which burner will be the best fit for you.

## BURNER MATCH FOR COMMON INTERIOR DIMENSIONS for Circular or Square Fire Pits

INTERIOR DIMENSION	CIRCULAR	SQUARE
18"	CFB60	CFB60
	CFB84	CFB84
	CFBCTL120	CFBST120
	CFBO140	CFBO140
24"	CFB120	CFB120
	CFBCTL120	CFBO180
	CFBO180	
30"	CFB180	CFB180
	CFB240	CFB240
	CFBCT240	CFBST240
	CFBO280	CFBO280
36"	CFB240	CFB240
	CFB290	CFB290
	CFBO280	CFBO280
		CFBST400
42"	CFB350	CFB350
	CFBCT440	CFBST500
	CFBO360	CFBO360
48"	CFB350	CFB350
60"	CFB450	CFB450

### TECH TIP

*Paver Kits are becoming more popular and Warming Trends offers kits - including burner, plate, flex line and key valve kits - specifically designed to work with a variety of paver company block features. See page 57 for our Universal Paver Kit selection.*

*Warming Trends burners come standard as Match Lit Systems but fully automatic ignition systems are available and are recommended for 300K BTU systems and larger. Ignition systems can be found on page 61.*



## BURNER, PLATE, PARTS & IGNITION COMPATIBILITY

Not all burners shown below.

	Plate/Pan (inches)	Circular Plate	Square Plate	Rectangular Plate	FK1	FK2	PBIK	3VIK	24VIKHC	P24VIKSCCG	P24VIKHCCG
<b>ORIGINAL</b>											
CFB60	18"	X	X		X		X	X	X	X	
CFB84	18"	X	X		X		X	X	X	X	
CFB120	24"	X	X		X		X	X	X	X	
CFB180	30"	X	X		X		X		X	X	
CFB240	30"	X	X		X		X		X	X	
CFB290	36"	X	X			X	X		X	X	
CFB350	48"	X	X			X			X		X
CFB450	60"	X	X			X					X
<b>OCTAGONAL</b>											
CFBO140	18"	X	X		X		X		X	X	
CFBO180	24"	X	X		X		X		X	X	
CFBO280	30"	X	X			X	X		X	X	
CFBO360	42"	X	X			X			X		X
<b>TREE-STYLES</b>											
CFBT110	11" x 20"			X	X		X	X	X	X	
CFBT170	11" x 28"			X	X		X		X	X	
CFBT230	11" x 36"			X	X		X		X	X	
CFBT290	14" x 44"			X		X	X		X	X	
CFBT350	14" x 58"			X		X			X		X
CFBT410	14" x 66"			X		X					X
CFBT470	14" x 74"			X		X					X
<b>LINEARS</b>											
CFBL90	6" x 20"			X	X		X	X	X	X	
CFBL110	6" x 26"			X	X		X	X	X	X	
CFBL130	8" x 32"			X	X		X	X	X	X	
CFBL150	8" x 38"			X	X		X		X	X	
CFBL190	8" x 44"			X	X		X		X	X	
CFBL210	10" x 50"			X	X		X		X	X	
CFBL250	10" x 56"			X		X	X		X	X	
CFBL270	12" x 62"			X		X	X		X	X	

Find inspirational photos, videos, and more on our website  
[www.Warming-Trends.com](http://www.Warming-Trends.com)

# ELECTRONICS AND CLEARANCES

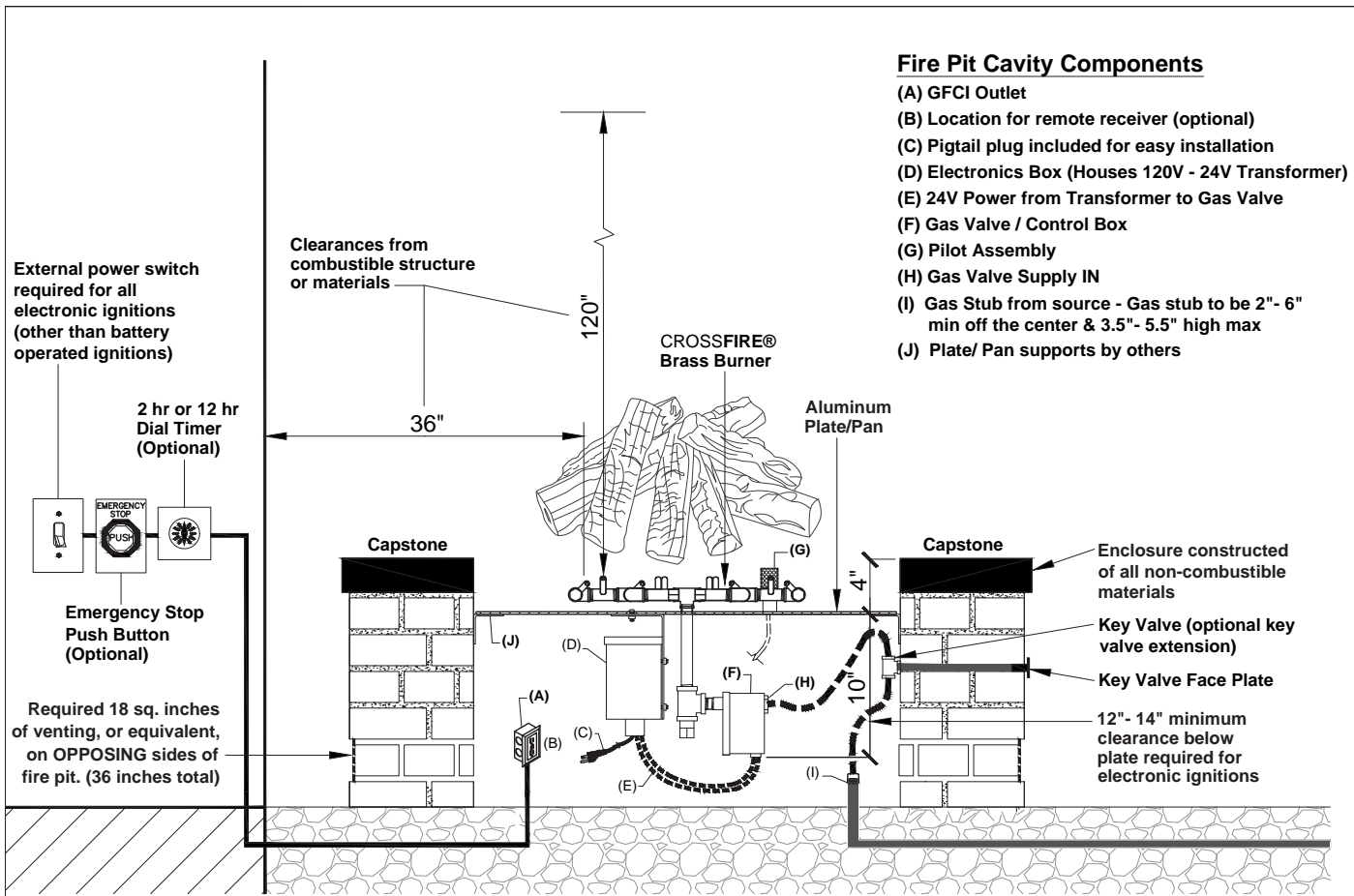

For Match Lit Diagram, please see page 4.

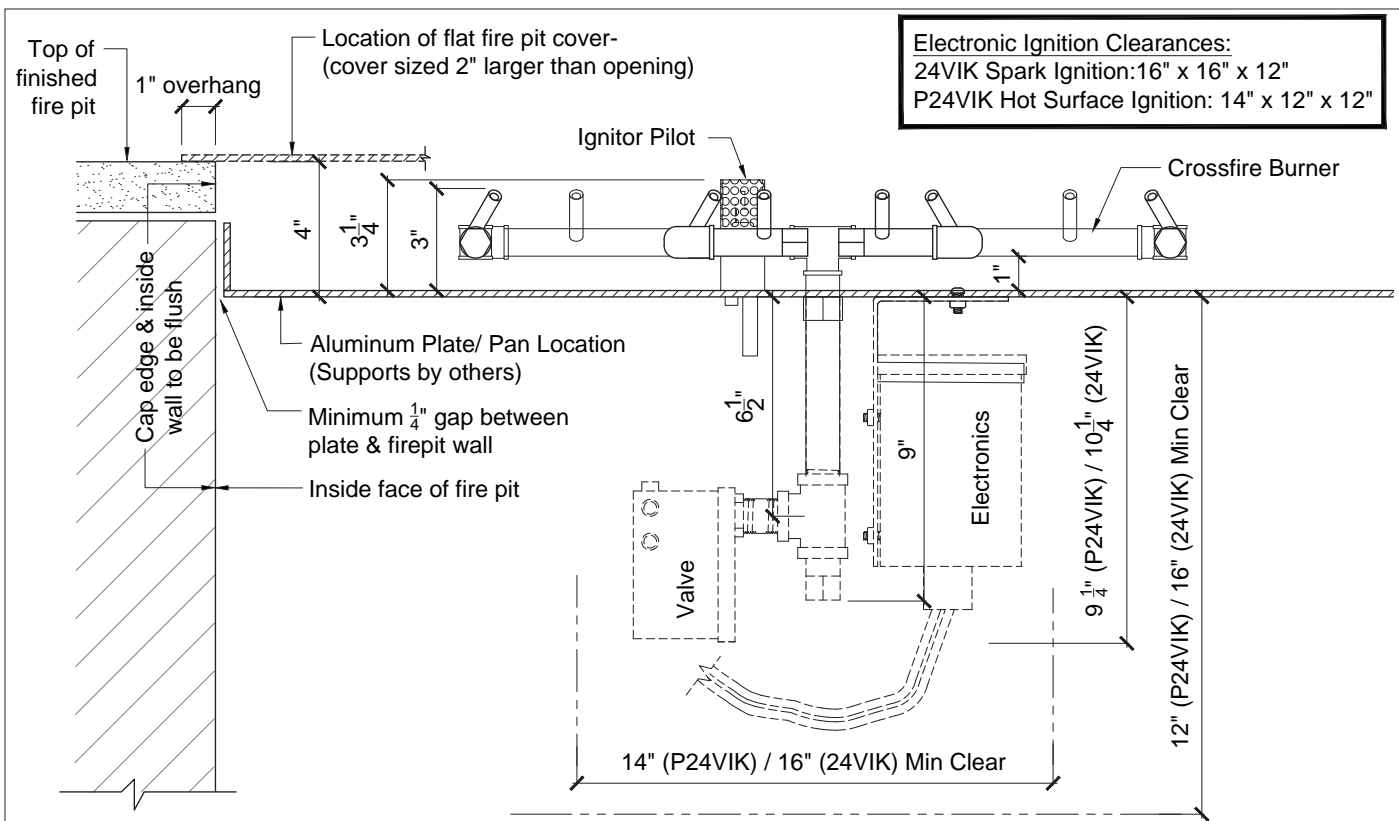



# CERTIFIED UNITS

Compliance with the following codes:

1. 2021, 2018, 2015, 2012, and 2009 *International Fire Code*® (IFC)
2. 2021, 2018, 2015, 2012, and 2009 *International Fuel Gas Code*® (IFGC)
3. 2018, 2015, 2012 and 2009 *Uniform Mechanical Code*® (UMC)\*
4. 2020, 2015 and 2010 *Natural Gas and Propane Installation Code*\*\*

\*Uniform Plumbing Code is a copyrighted publication of the International Association of Plumbing and Mechanical Officials

\*\*Copyrighted publication of Canadian Standard Association

Compliance with the following standards:

1. ANSI Z21.97/CSA 2.41-2017 Outdoor Decorative Gas Appliances

Product: Outdoor Decorative Gas Fire Pit and Fireplaces



ICC-ES Report PMG-1213

## MATCH LIT:

Model # CFB60 NG/LP as match lit  
 Model # CFB120 NG/LP as match lit  
 Model # CFB180 NG/LP as match lit  
 Model # CFB240 NG/LP as match lit  
 Model # CFB290 NG/LP as match lit  
 Model # CFB90 NG/LP as match lit  
 Model # CFBL110 NG/LP as match lit  
 Model # CFBL130 NG/LP as match lit  
 Model # CFBL150 NG/LP as match lit  
 Model # CFBL190 NG/LP as match lit  
 Model # CFBL210 NG/LP as match lit  
 Model # CFBL250 NG/LP as match lit  
 Model # CFBL270 NG/LP as match lit  
 Model # CFBL320 NG/LP as matchlit  
 Model # CFB60 2XL NG/LP as match lit  
 Model # CFBH120 NG/LP as match lit  
 Model # CFBH160 NG/LP as match lit  
 Model # CFBH200 NG/LP as match lit  
 Model # CFBH240 NG/LP as match lit  
 Model # CFBH260 NG/LP as match lit  
 Model # CFBH300 NG/LP as match lit  
 Model # CFBH340 NG/LP as match lit  
 Model # CFBH420 NG/LP as match lit  
 Model # CFBT110 NG/LP as match lit  
 Model # CFBT170 NG/LP as match lit  
 Model # CFBT230 NG/LP as match lit  
 Model # CFBT290 NG/LP as match lit  
 Model # CFBT350 NG/LP as match lit  
 Model # CFBT410 NG/LP as match lit  
 Model # CFBT470 NG/LP as match lit  
 Model # CFBO180 NG/LP as match lit  
 Model # CFBO280 NG/LP as match lit  
 Model # CFBO360 NG/LP as match lit  
 Model # WTV40 NG/LP as matchlit  
 Model # WTV60 NG/LP as matchlit  
 Model # WTV120 NG/LP as matchlit  
 Model # WTV120 NG/LP as matchlit  
 Model # WTV180 NG/LP as matchlit  
 Model # WTVES120 NG/LP as matchlit  
 Model # WTVES180 NG/LP as matchlit  
 Model # WT230 NG/LP as matchlit  
 Model # WTV350 NG/LP as matchlit

## SPARK IGNITER OPERATED UNITS

Model # WTV40 NG/LP with PBIK  
 Model # WTV60 NG/LP with PBIK  
 Model # CFB60 2XL NG/LP with PBIK  
 Model # CFB60 NG/LP with PBIK  
 Model # CFB120 NG/LP with PBIK  
 Model # CFB180 NG/LP with PBIK  
 Model # CFB290 NG/LP with PBIK  
 Model # CFBH120 NG/LP with PBIK  
 Model # CFBH160 NG/LP with PBIK  
 Model # CFBH200 NG/LP with PBIK  
 Model # CFBH240 NG/LP with PBIK  
 Model # CFBH260 NG/LP with PBIK  
 Model # CFBH300 NG/LP with PBIK  
 Model # CFBH340 NG/LP with PBIK  
 Model # CFBH420 NG/LP with PBIK  
 Model # CFBL90 NG/LP with PBIK  
 Model # CFBL110 NG/LP with PBIK  
 Model # CFBL130 NG/LP with PBIK  
 Model # CFBL150 NG/LP with PBIK  
 Model # CFBL170 NG/LP with PBIK  
 Model # CFBL180 NG/LP with PBIK  
 Model # CFBL210 NG/LP with PBIK

Model # CFBL250 NG/LP with PBIK  
 Model # CFBL270 NG/LP with PBIK  
 Model # CFBL320 NG/LP with PBIK  
 Model # CFBO180 NG/LP with PBIK  
 Model # CFBO280 NG/LP with PBIK  
 Model # CFBO360 NG/LP with PBIK  
 Model # CFBT110 NG/LP with PBIK  
 Model # CFBT170 NG/LP with PBIK  
 Model # CFBT230 NG/LP with PBIK  
 Model # CFBT290 NG/LP with PBIK  
 Model # CFBT350 NG/LP with PBIK  
 Model # CFBT410 NG/LP with PBIK  
 Model # CFBT470 NG/LP with PBIK  
 Model # WTV120 NG/LP with PBIK  
 Model # WTV180 NG/LP with PBIK  
 Model # WTVES120 NG/LP with PBIK  
 Model # WTVES180 NG/LP with PBIK  
 Model # WTVT230 NG/LP with PBIK  
 Model # WTVT350 NG/LP with PBIK

## 3V BATTERY OPERATED UNITS

Model # CFB60 NG/LP with 3VIK  
 Model # CFB120 NG/LP with 3VIK  
 Model # CFB240 NG/LP with 3VIK  
 Model # CFBL90LP NG/LP with 3VIK  
 Model # CFBL110LP NG/LP with 3VIK  
 Model # CFBL130LP NG/LP with 3VIK  
 Model # CFBL150LP NG/LP with 3VIK  
 Model # CFBL190LP NG/LP with 3VIK  
 Model # CFBL210LP NG/LP with 3VIK  
 Model # CFBL250LP NG/LP with 3VIK  
 Model # CFB60 2XL NG/LP with 3VIK  
 Model # CFBH120LP NG/LP with 3VIK  
 Model # CFBH160LP NG/LP with 3VIK  
 Model # CFBH200LP NG/LP with 3VIK  
 Model # CFBH240LP NG/LP with 3VIK  
 Model # CFBH260LP NG/LP with 3VIK  
 Model # CFBH300LP NG/LP with 3VIK  
 Model # CFBH340LP NG/LP with 3VIK  
 Model # CFBT110LP NG/LP with 3VIK  
 Model # CFBT170LP NG/LP with 3VIK  
 Model # CFBT230LP NG/LP with 3VIK  
 Model # CFBT290LP NG/LP with 3VIK  
 Model # CFBT350LP NG/LP with 3VIK  
 Model # CFBT410LP NG/LP with 3VIK  
 Model # CFBT470LP NG/LP with 3VIK  
 Model # CFBO180 NG/LP with 3VIK  
 Model # CFBO280 NG/LP with 3VIK  
 Model # CFBO360 NG/LP with 3VIK  
 Model # WTV60 NG/LP with 3VIK  
 Model # WTV120 NG/LP with 3VIK  
 Model # WTV180 NG/LP with 3VIK

## 24 VOLT STANDARD ELECTRONIC IGNITION SYSTEMS - Standard Capacity

Model # CFB60 NG/LP with 24VIKSC  
 Model # CFB120 NG/LP with 24VIKSC  
 Model # CFB180 NG/LP with 24VIKSC  
 Model # CFB240 NG/LP with 24VIKSC  
 Model # CFB90 NG/LP with 24VIKSC  
 Model # CFBL110 NG/LP with 24VIKSC  
 Model # CFBL130 NG/LP with 24VIKSC  
 Model # CFBL150 NG/LP with 24VIKSC  
 Model # CFBL190 NG/LP with 24VIKSC  
 Model # CFB60 2XL NG/LP with 24VIKSC  
 Model # CFBH120 NG/LP with 24VIKSC  
 Model # CFBH160 NG/LP with 24VIKSC  
 Model # CFBH200 NG/LP with 24VIKSC  
 Model # CFBH240 NG/LP with 24VIKSC  
 Model # CFBH260 NG/LP with 24VIKSC  
 Model # CFBH300 NG/LP with 24VIKSC  
 Model # CFBH340 NG/LP with 24VIKSC  
 Model # CFBH420 NG/LP with 24VIKSC  
 Model # CFBT110 NG/LP with 24VIKSC  
 Model # CFBT170 NG/LP with 24VIKSC  
 Model # CFBT230 NG/LP with 24VIKSC  
 Model # CFBT290 NG/LP with 24VIKSC  
 Model # CFBT350 NG/LP with 24VIKSC  
 Model # CFBT410 NG/LP with 24VIKSC  
 Model # CFBT470 NG/LP with 24VIKSC  
 Model # CFBO180 NG/LP with 24VIKSC  
 Model # CFBO280 NG/LP with 24VIKSC  
 Model # CFBO360 NG/LP with 24VIKSC  
 Model # WTV60 NG/LP with 24VIKSC  
 Model # WTV120 NG/LP with 24VIKSC  
 Model # WTV180 NG/LP with 24VIKSC

## 24 VOLT STANDARD ELECTRONIC IGNITION SYSTEMS - High Capacity

Model # CFB240 NG/LP with 24VIKHC  
 Model # CFB290 NG/LP with 24VIKHC  
 Model # CFB300 NG/LP with 24VIKHC  
 Model # CFBL210 NG/LP with 24VIKHC  
 Model # CFBL250 NG/LP with 24VIKHC  
 Model # CFBL270 NG/LP with 24VIKHC  
 Model # CFBL320 NG/LP with 24VIKHC  
 Model # CFBH240 NG/LP with 24VIKHC  
 Model # CFBH260 NG/LP with 24VIKHC  
 Model # CFBH300 NG/LP with 24VIKHC  
 Model # CFBH340 NG/LP with 24VIKHC  
 Model # CFBH420 NG/LP with 24VIKHC  
 Model # CFBT230 NG/LP with 24VIKHC  
 Model # CFBT290 NG/LP with 24VIKHC  
 Model # CFBT350 NG/LP with 24VIKHC  
 Model # CFBT410 NG/LP with 24VIKHC  
 Model # CFBT470 NG/LP with 24VIKHC  
 Model # CFBO180 NG/LP with 24VIKHC  
 Model # CFBO280 NG/LP with 24VIKHC  
 Model # CFBO360 NG/LP with 24VIKHC  
 Model # WTV60 NG/LP with 24VIKHC  
 Model # WTV120 NG/LP with 24VIKHC  
 Model # WTV180 NG/LP with 24VIKHC

## 24 VOLT PREMIUM ELECTRONIC IGNITION SYSTEMS - Standard Capacity

Model # CFB60 NG/LP with P24VIKSC  
 Model # CFB120 NG/LP with P24VIKSC  
 Model # CFB180 NG/LP with P24VIKSC  
 Model # CFB240 NG/LP with P24VIKSC  
 Model # CFB90 NG/LP with P24VIKSC  
 Model # CFBL110 NG/LP with P24VIKSC  
 Model # CFBL130 NG/LP with P24VIKSC  
 Model # CFBL150 NG/LP with P24VIKSC  
 Model # CFBL190 NG/LP with P24VIKSC  
 Model # CFB60 2XL NG/LP with P24VIKSC  
 Model # CFBH120 NG/LP with P24VIKSC  
 Model # CFBH160 NG/LP with P24VIKSC  
 Model # CFBH200 NG/LP with P24VIKSC  
 Model # CFBH240 NG/LP with P24VIKSC  
 Model # CFBH260 NG/LP with P24VIKSC  
 Model # CFBH300 NG/LP with P24VIKSC  
 Model # CFBH340 NG/LP with P24VIKSC  
 Model # CFBH420 NG/LP with P24VIKSC  
 Model # CFBT110 NG/LP with P24VIKSC  
 Model # CFBT170 NG/LP with P24VIKSC  
 Model # CFBT230 NG/LP with P24VIKSC  
 Model # CFBT290 NG/LP with P24VIKSC  
 Model # CFBO180 NG/LP with P24VIKSC  
 Model # CFBO280 NG/LP with P24VIKSC  
 Model # CFBO360 NG/LP with P24VIKSC  
 Model # WTV60 NG/LP with P24VIKSC  
 Model # WTV120 NG/LP with P24VIKSC  
 Model # WTV180 NG/LP with P24VIKSC

## 24 VOLT PREMIUM ELECTRONIC IGNITION SYSTEMS - High Capacity

Model # CFB300 NG/LP with P24VIKHC  
 Model # CFBL320 NG/LP with P24VIKHC  
 Model # CFBH300 NG/LP with P24VIKHC  
 Model # CFBH340 NG/LP with P24VIKHC  
 Model # CFBH420 NG/LP with P24VIKHC  
 Model # CFBT350 NG/LP with P24VIKHC  
 Model # CFBT410 NG/LP with P24VIKHC  
 Model # CFBT470 NG/LP with P24VIKHC  
 Model # CFBO360 NG/LP with P24VIKHC  
 Model # WTV120 NG/LP with P24VIKHC

High Capacity (HC) ignitions may be substituted for Standard Capacity (SC) ignitions.

V1.R3



## OPTIONS FOR CIRCULAR OPENINGS

---

Designed for circular fire features, these **CROSSFIRE**<sup>®</sup> Brass Burners range from 60K to 450K BTUs.

Need a different size or shape? We're happy to help. Call our Flame Consultants at 877 556 5255



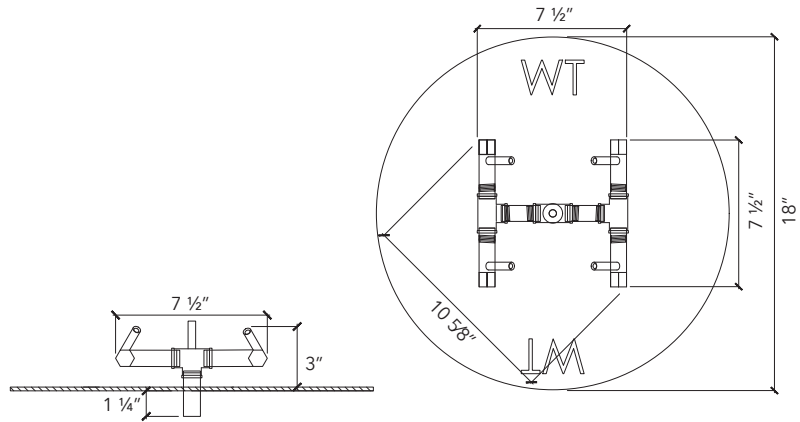

**ORIGINAL CFB60**  
For 18" opening or larger

SKU (NG OR LP)	DESCRIPTION	SHIP WEIGHT	SHIP DIMENSIONS
CFB60NG   CFB60LP	60K BTU Original Brass Burner	4 lbs	11" x 11" x 5"
Recommended parts: Plate: ALPL18C (circle) • 3/4" Flex Line Kit • Optional 3x Support Collars			
CFB60NGALPL18C CFB60LPALPL18C	with 18" Circular Plate	9 lbs	19" x 19" x 7"
CFB60NGALPL18CFK1 CFB60LPALPL18CFK1	with 18" Circular Plate + 3/4" Flex Line Kit	12 lbs	19" x 19" x 7"
Compatible Ignition Systems: Push Button, 3 Volt, 24 Volt Spark Ignition, 24 Volt Hot Surface Ignition (SC)			

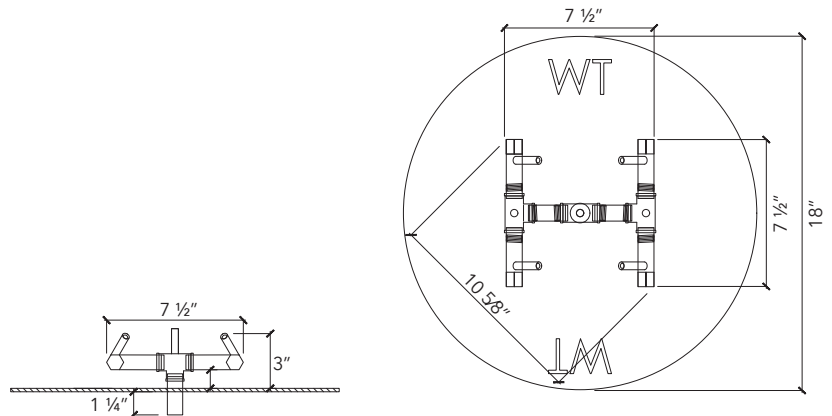

**ORIGINAL CFB84**  
For 18" opening or larger

SKU (NG OR LP)	DESCRIPTION	SHIP WEIGHT	SHIP DIMENSIONS
CFB84NG   CFB84LP	84K BTU Original Brass Burner	4 lbs	11" x 11" x 5"
Recommended parts: Plate: ALPL18C (circle) • 3/4" Flex Line Kit • Optional 3x Support Collars			
CFB84NGALPL18C CFB84LPALPL18C	with 18" Circular Plate	9 lbs	19" x 19" x 7"
CFB84NGALPL18CFK1 CFB84LPALPL18CFK1	with 18" Circular Plate + 3/4" Flex Line Kit	12 lbs	19" x 19" x 7"
Compatible Ignition Systems: Push Button, 3 Volt, 24 Volt Spark Ignition, 24 Volt Hot Surface Ignition (SC)			

**SKU BREAKDOWN** **CFB O 3 6 0 N G A L P L 4 2 C F K 2**

	Octagonal (Burner Type)	Gas Type	Size of Plate	Flex Line Kit
CROSSFIRE Brass Burner	BTU	Plate or Pan	Shape of Plate	

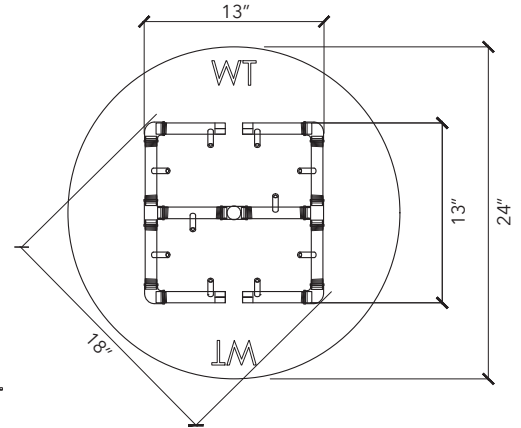
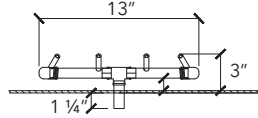
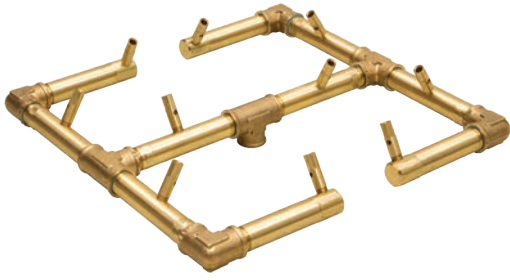

**ORIGINAL CFB120**  
For 24" opening or larger

SKU (NG OR LP)	DESCRIPTION	SHIP WEIGHT	SHIP DIMENSIONS
CFB120NG   CFB120LP	120K BTU Original Brass Burner	8 lbs	15" x 15" x 5"
Recommended parts: Plate: ALPL24C (circle) • 3/4" Flex Line Kit • Optional 4x Support Collars			
CFB120NGALPL24C CFB120LPALPL24C	with 24" Circular Plate	13 lbs	25" x 25" x 7"
CFB120NGALPL24CFK1 CFB120LPALPL24CFK1	with 24" Circular Plate + 3/4" Flex Line Kit	16 lbs	25" x 25" x 7"
Compatible Ignition Systems: Push Button, 3 Volt, 24 Volt Spark Ignition, 24 Volt Hot Surface Ignition (SC)			

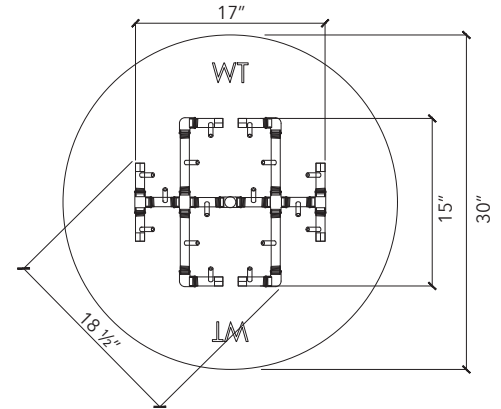
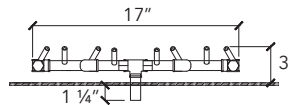
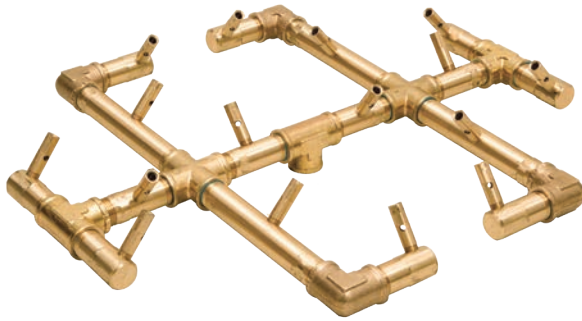

**ORIGINAL CFB180**  
For 30" opening or larger

SKU (NG OR LP)	DESCRIPTION	SHIP WEIGHT	SHIP DIMENSIONS
CFB180NG   CFB180LP	180K BTU Original Brass Burner	9 lbs	19" x 19" x 7"
Recommended parts: Plate: ALPL30C (circle) • 3/4" Flex Line Kit • Optional 5x Support Collars			
CFB180NGALPL30C CFB180LPALPL30C	with 30" Circular Plate	17 lbs	31" x 31" x 7"
CFB180NGALPL30CFK1 CFB180LPALPL30CFK1	with 30" Circular Plate + 3/4" Flex Line Kit	20 lbs	31" x 31" x 7"
Compatible Ignition Systems: Push Button, 24 Volt Spark Ignition, 24 Volt Hot Surface Ignition (SC)			

**PLATE AND PAN OPTIONS ON PAGE 44**

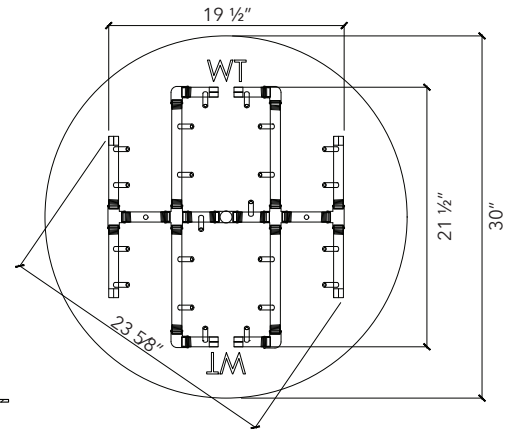
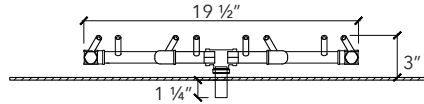

## ORIGINAL CFB240

For 30" opening or larger

SKU (NG OR LP)

DESCRIPTION

SHIP WEIGHT

SHIP DIMENSIONS

CFB240NG   CFB240LP	240K BTU Original Brass Burner	12 lbs	23" x 23" x 7"
Recommended parts: Plate: ALPL30C (circle) • 3/4" Flex Line Kit • Optional 5x Support Collars			
CFB240NGALPL30C CFB240LPALPL30C	with 30" Circular Plate	20 lbs	31" x 31" x 7"
CFB240NGALPL30CFK1 CFB240LPALPL30CFK1	with 30" Circular Plate + 3/4" Flex Line Kit	23 lbs	31" x 31" x 7"
Compatible Ignition Systems: Push Button, 24 Volt Spark Ignition, 24 Volt Hot Surface Ignition (SC)			

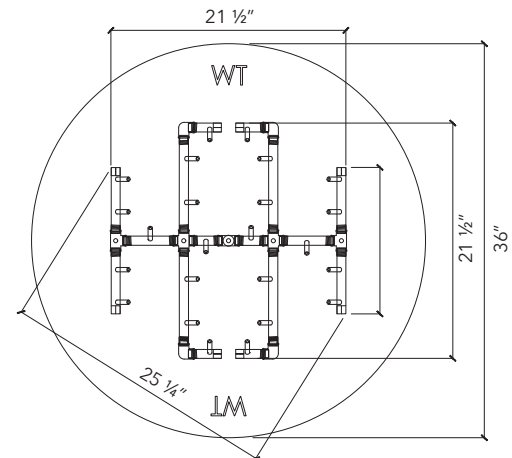
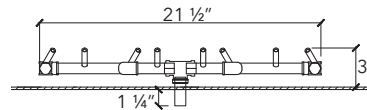
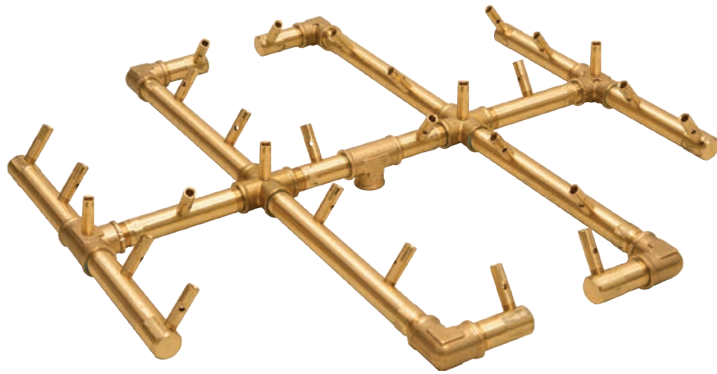

## ORIGINAL CFB290

For 36" opening or larger

SKU (NG OR LP)

DESCRIPTION

SHIP WEIGHT

SHIP DIMENSIONS

CFB290NG   CFB290LP	290K BTU Original Brass Burner	12 lbs	23" x 23" x 7"
Recommended parts: Plate: ALPL36C (circle) • 3/4" Dual Flex Line Kit • Optional 6x Support Collars			
CFB290NGALPL36C CFB290LPALPL36C	with 36" Circular Plate	24 lbs	37" x 37" x 9"
CFB290NGALPL36CFK2 CFB290LPALPL36CFK2	with 36" Circular Plate + 3/4" Dual Flex Line Kit	27 lbs	37" x 37" x 9"
Compatible Ignition Systems: Push Button, 24 Volt Spark Ignition, 24 Volt Hot Surface Ignition (SC)			

**SKU BREAKDOWN**

CFB	O	360	NG	ALPL	42C	FK2
CROSSFIRE Brass Burner		BTU	Gas Type	Plate or Pan	Shape of Plate	Flex Line Kit



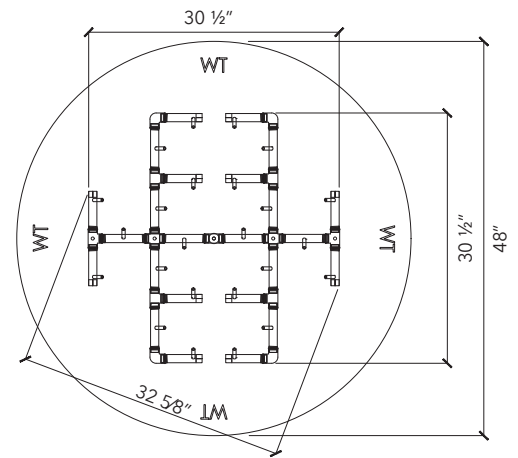
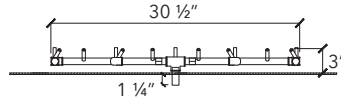
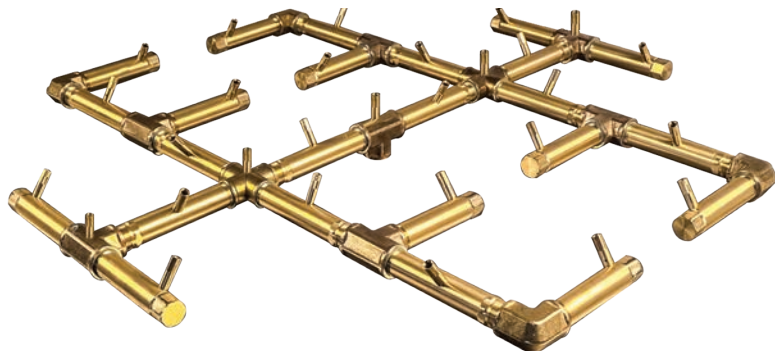

## ORIGINAL CFB350

For 48" opening or larger

SKU (NG OR LP)

DESCRIPTION

SHIP WEIGHT

SHIP DIMENSIONS

CFB350NG   CFB350LP	350K BTU Original Brass Burner	23 lbs	33" x 33" x 9"
Recommended parts: Plate: ALPL48C (circle) • 3/4" Dual Flex Line Kit • Optional 8x Support Collars			
CFB350NGALPL48C CFB350LPALPL48C	with 48" Circular Plate		SHIPS FREIGHT
CFB350NGALPL48CFK2 CFB350LPALPL48CFK2	with 48" Circular Plate + 3/4" Dual Flex Line Kit		SHIPS FREIGHT
Compatible Ignition Systems: 24 Volt Spark Ignition, 24 Volt Hot Surface Ignition (HC)			

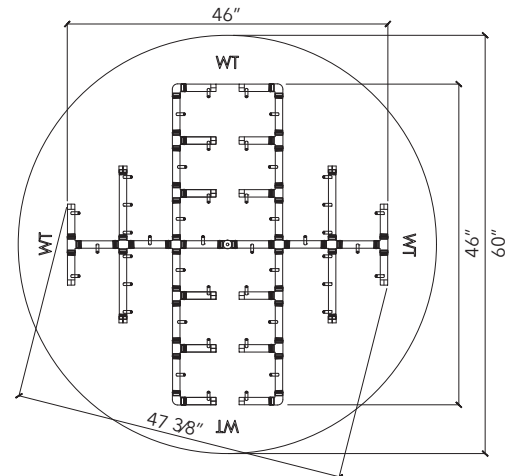
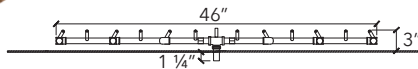
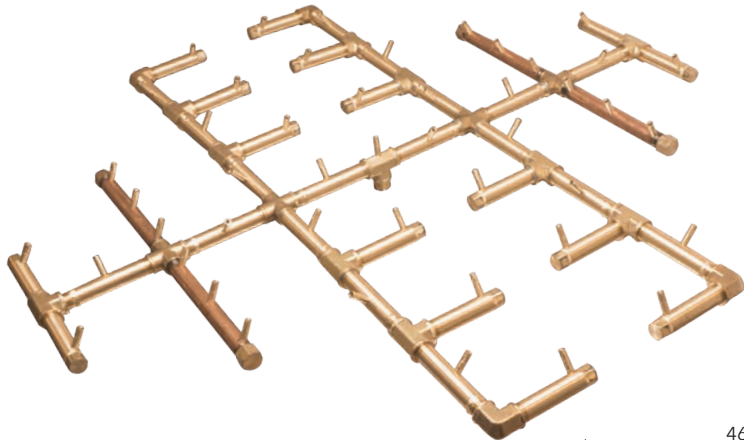

## ORIGINAL CFB450

For 60" opening or larger

SKU (NG OR LP)

DESCRIPTION

SHIP WEIGHT

SHIP DIMENSIONS

CFB450NG   CFB450LP	450K BTU Original Brass Burner		SHIPS FREIGHT
Recommended parts: Plate: ALPL60C (circle) • 3/4" Dual Flex Line Kit • Optional 10x Support Collars			
CFB450NGALPL60C CFB450LPALPL60C	with 60" Circular Plate		SHIPS FREIGHT
CFB450NGALPL60CFK2 CFB450LPALPL60CFK2	with 60" Circular Plate + 3/4" Dual Flex Line Kit		SHIPS FREIGHT
Compatible Ignition Systems: 24 Volt Spark Ignition, 24 Volt Hot Surface Ignition (HC)			

**LIGHT IT UP! IGNITION SYSTEMS START ON PAGE 61**

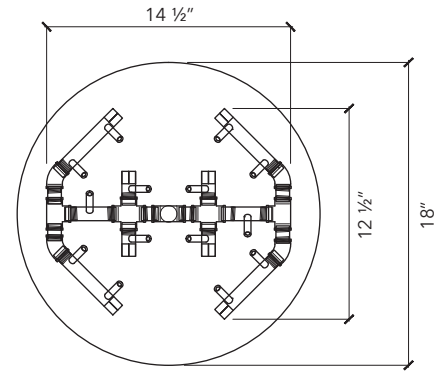
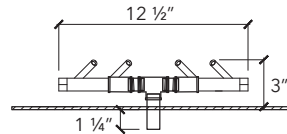

## OCTAGONAL CFBO140

For 18" opening or larger

SKU (NG OR LP)	DESCRIPTION	SHIP WEIGHT	SHIP DIMENSIONS
CFBO140NG   CFBO140LP	140K BTU Octagonal Brass Burner	9 lbs	19" x 15" x 5"
Recommended parts: Plate: ALPL18C (circle) • 3/4" Flex Line Kit • Optional 3x Support Collars			
CFBO140NGALPL18C CFBO140LPALPL18C	with 18" Circular Plate	13 lbs	19" x 19" x 7"
CFBO140NGALPL18CFK1 CFBO140LPALPL18CFK1	with 18" Circular Plate + 3/4" Flex Line Kit	17 lbs	19" x 19" x 7"
Compatible Ignition Systems: Push Button, 24 Volt Spark Ignition, 24 Volt Hot Surface Ignition (SC)			

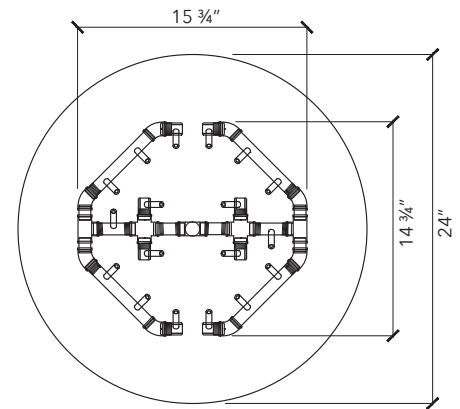
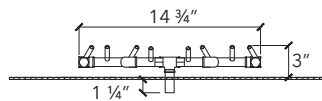
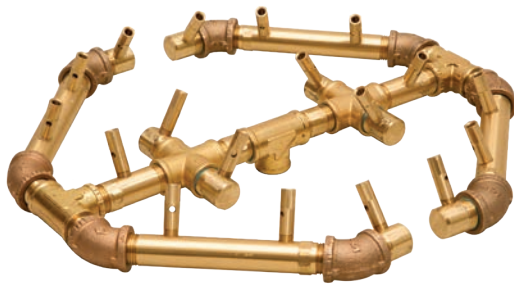

## OCTAGONAL CFBO180

For 24" opening or larger

SKU (NG OR LP)	DESCRIPTION	SHIP WEIGHT	SHIP DIMENSIONS
CFBO180NG   CFBO180LP	180K BTU Octagonal Brass Burner	10 lbs	19" x 15" x 5"
Recommended parts: Plate: ALPL24C (circle) • 3/4" Flex Line Kit • Optional 4x Support Collars			
CFBO180NGALPL24C CFBO180LPALPL24C	with 24" Circular Plate	15 lbs	25" x 25" x 7"
CFBO180NGALPL24CFK1 CFBO180LPALPL24CFK1	with 24" Circular Plate + 3/4" Flex Line Kit	18 lbs	25" x 25" x 7"
Compatible Ignition Systems: Push Button, 24 Volt Spark Ignition, 24 Volt Hot Surface Ignition (SC)			

**SKU BREAKDOWN**

CF	B	O	3	6	0	NG	A	L	P	L	4	2	C	F	K	2
CROSSFIRE Brass Burner			BTU				Plate or Pan		Shape of Plate		Size of Plate		Flex Line Kit			

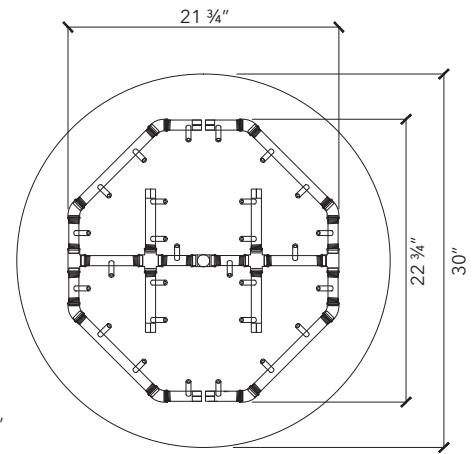
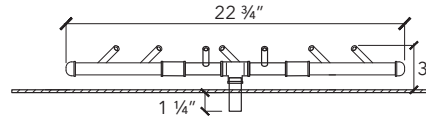
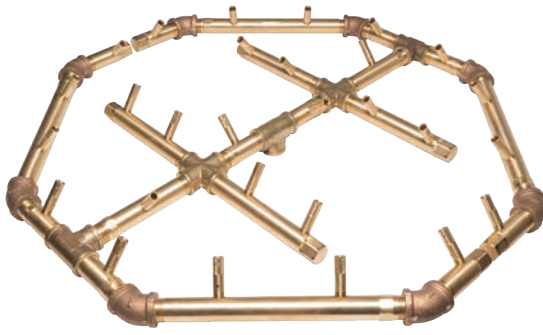

## OCTAGONAL CFBO280

For 30" opening or larger

SKU (NG OR LP)

DESCRIPTION

SHIP WEIGHT

SHIP DIMENSIONS

CFBO280NG   CFBO280LP	280K BTU Octagonal Brass Burner	13 lbs	25" x 25" x 7"
Recommended parts: Plate: ALPL30C (circle) • 3/4" Dual Flex Line Kit • Optional 5x Support Collars			
CFBO280NGALPL30C CFBO280LPALPL30C	with 30" Circular Plate	21 lbs	31" x 31" x 7"
CFBO280NGALPL30CFK2 CFBO280LPALPL30CFK2	with 30" Circular Plate + 3/4" Dual Flex Line Kit	24 lbs	31" x 31" x 7"
Compatible Ignition Systems: Push Button, 24 Volt Spark Ignition, 24 Volt Hot Surface Ignition (HC)			

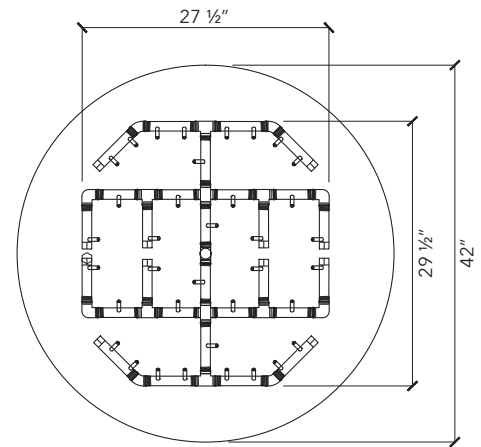
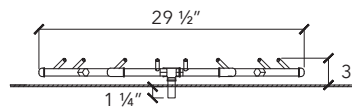
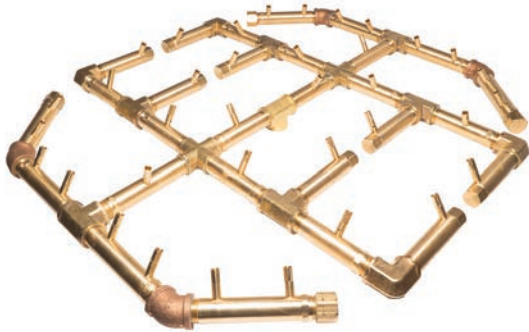

## OCTAGONAL CFBO360

For 42" opening or larger

SKU (NG OR LP)

DESCRIPTION

SHIP WEIGHT

SHIP DIMENSIONS

CFB360NG   CFB360LP	360K BTU Octagonal Brass Burner	22 lbs	31" x 31" x 7"
Recommended parts: Plate: ALPL42C (circle) • 3/4" Dual Flex Line Kit • Optional 7x Support Collars			
CFB360NGALPL42C CFB360LPALPL42C	with 42" Circular Plate		SHIPS FREIGHT
CFB360NGALPL42CFK2 CFB360LPALPL42CFK2	with 42" Circular Plate + 3/4" Dual Flex Line Kit		SHIPS FREIGHT
Compatible Ignition Systems: 24 Volt Spark Ignition, 24 Volt Hot Surface Ignition (HC)			

**FLEX LINE AND PARTS ON PAGE 65**



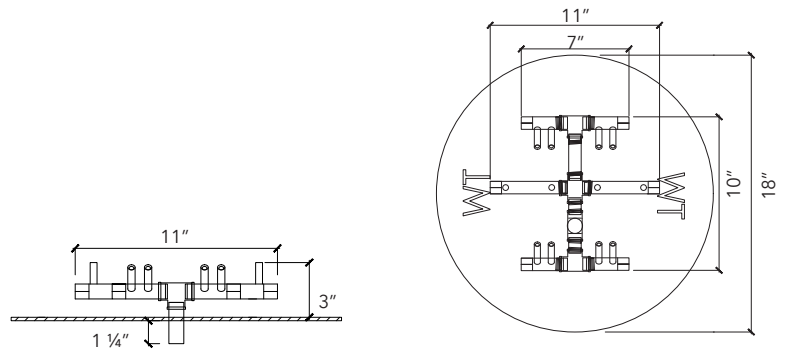

## CIRCLE TREE-STYLE CFBCTL120

For 18" opening or larger

SKU (NG OR LP)	DESCRIPTION	SHIP WEIGHT	SHIP DIMENSIONS
CFBCTL120NG   CFBCTL120LP	120K BTU Circle Tree-Style Brass Burner	5 lbs	11" x 11" x 5"
Recommended parts: Plate: ALPL18C (circle) • 3/4" Flex Line Kit • Optional 3x Support Collars			
CFBCTL120NGALPL18C CFBCTL120LPALPL18C	with 18" Circular Plate	12 lbs	19" x 19" x 7"
CFBCTL120NGALPL18CFK1 CFBCTL120LPALPL18CFK1	with 18" Circular Plate + 3/4" Flex Line Kit	15 lbs	19" x 19" x 7"
Compatible Ignition Systems: Push Button, 3 Volt, 24 Volt Spark Ignition, 24 Volt Hot Surface Ignition (SC)			

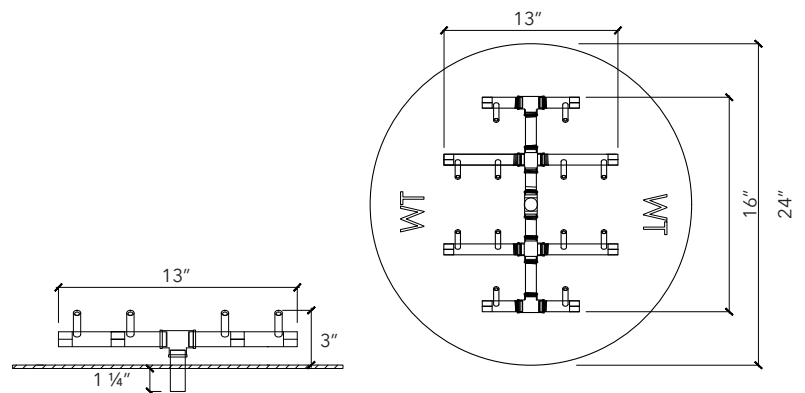

## CIRCLE TREE-STYLE CFBCTXL120

For 24" opening or larger

SKU (NG OR LP)	DESCRIPTION	SHIP WEIGHT	SHIP DIMENSIONS
CFBCTXL120NG   CFBCTXL120LP	120K BTU Circle Tree-Style Brass Burner	7 lbs	11" x 11" x 5"
Recommended parts: Plate: ALPL24C (circle) • 3/4" Flex Line Kit • Optional 4x Support Collars			
CFBCTXL120NGALPL24C CFBCTXL120LPALPL24C	with 24" Circular Plate	18 lbs	25" x 25" x 7"
CFBCTXL120NGALPL24CFK1 CFBCTXL120LPALPL24CFK1	with 24" Circular Plate + 3/4" Flex Line Kit	21 lbs	25" x 25" x 7"
Compatible Ignition Systems: Push Button, 3 Volt, 24 Volt Spark Ignition, 24 Volt Hot Surface Ignition (SC)			

**SKU BREAKDOWN**

C	F	B	O	3	6	0	N	G	A	L	P	L	4	2	C	F	K	2
CROSSFIRE Brass Burner				BTU			Gas Type		Plate or Pan			Shape of Plate			Flex Line Kit			

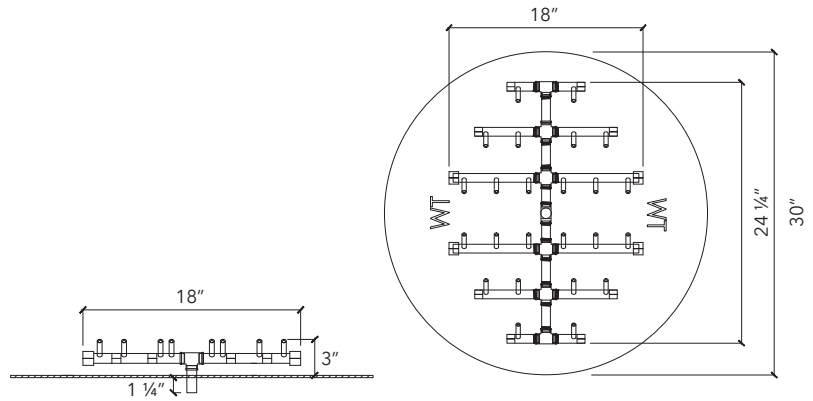

## CIRCLE TREE-STYLE CFBCT240

For 30" opening or larger

SKU (NG OR LP)

DESCRIPTION

SHIP WEIGHT

SHIP DIMENSIONS

CFBCT240NG   CFBCT240LP	240K BTU Circle Tree-Style Brass Burner	11 lbs	27" x 27" x 7"
Recommended parts: Plate: ALPL30C (circle) • 3/4" Flex Line Kit • Optional 5x Support Collars			
CFBCT240NGALPL30C CFBCT240LPALPL30C	with 30" Circular Plate	22 lbs	31" x 31" x 7"
CFBCT240NGALPL30CFK1 CFBCT240LPALPL30CFK1	with 30" Circular Plate + 3/4" Flex Line Kit	24 lbs	31" x 31" x 7"
Compatible Ignition Systems: Push Button, 24 Volt Spark Ignition, 24 Volt Hot Surface Ignition (SC)			

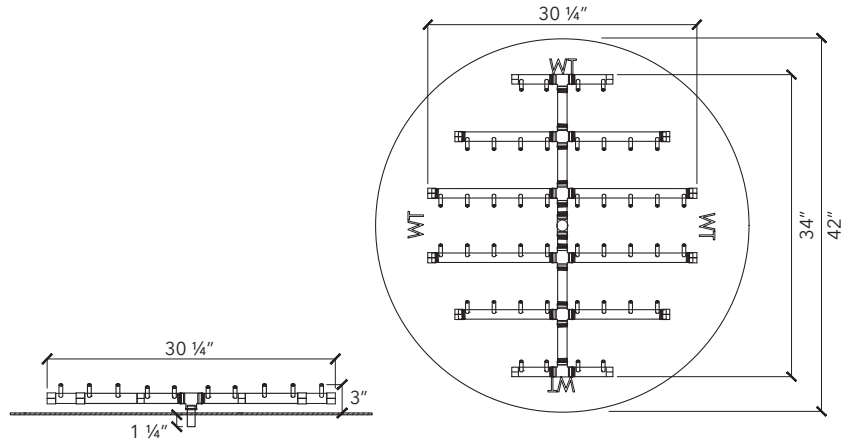
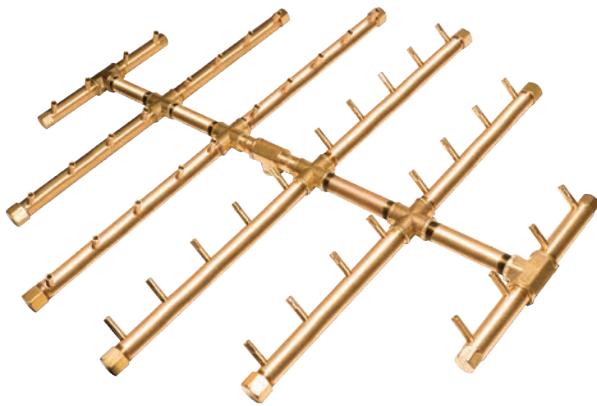

## CIRCLE TREE-STYLE CFBCT440

For 42" opening or larger

SKU (NG OR LP)

DESCRIPTION

SHIP WEIGHT

SHIP DIMENSIONS

CFBCT440NG   CFBCT4400LP	440K BTU Circle Tree-Style Brass Burner	30 lbs	37" x 37" x 9"
Recommended parts: Plate: ALPL42C (circle) • 3/4" Dual Flex Line Kit • Optional 7x Support Collars			
CFBCT440NGALPL42C CFBCT440LPALPL42C	with 42" Circular Plate		SHIPS FREIGHT
CFBCT440NGALPL42CFK2 CFBCT440LPALPL42CFK2	with 42" Circular Plate + 3/4" Dual Flex Line Kit		SHIPS FREIGHT
Compatible Ignition Systems: 24 Volt Hot Surface Ignition (HC)			

COMPLETE THE FEATURE WITH MEDIA, PAGE 66



Looking for something unique?  
In addition to standard products,  
Warming Trends works with customers  
every day to design and manufacture  
truly custom fire features.  
What can we design for you?

---

Call us today. We'd love to help. 877 556 5255

**WARMING**  **TRENDS**

Photo credit: Homestyle Landscaping





## OPTIONS FOR SQUARE OPENINGS

---

Designed for square fire features, these **CROSSFIRE®** Brass Burners range from 60K to 450K BTUs.

Need a different size or shape? We're happy to help. Call our Flame Consultants at 877 556 5255

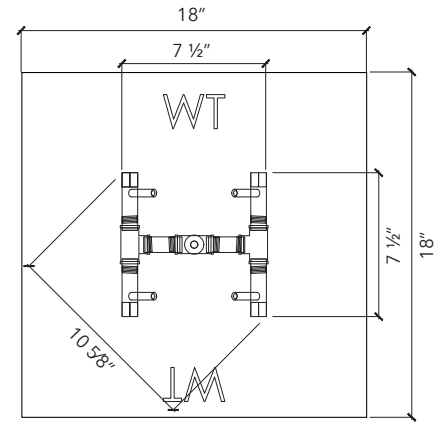
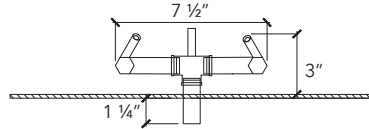

SQUARE OPENINGS

## ORIGINAL CFB60

For 18" opening or larger

SKU (NG OR LP)	DESCRIPTION	SHIP WEIGHT	SHIP DIMENSIONS
CFB60NG   CFB60LP	60K BTU Original Brass Burner	4 lbs	11" x 11" x 5"
Recommended parts: Plate: ALPL18S (square) • 3/4" Flex Line Kit • Optional 3x Support Collars			
CFB60NGALPL18S CFB60LPALPL18S	with 18" Square Plate	8 lbs	20" x 20" x 6"
CFB60NGALPL18SFK1 CFB60LPALPL18SFK1	with 18" Square Plate + 3/4" Flex Line Kit	11 lbs	20" x 20" x 6"
Compatible Ignition Systems: Push Button, 3 Volt, 24 Volt Spark Ignition, 24 Volt Hot Surface Ignition (SC)			

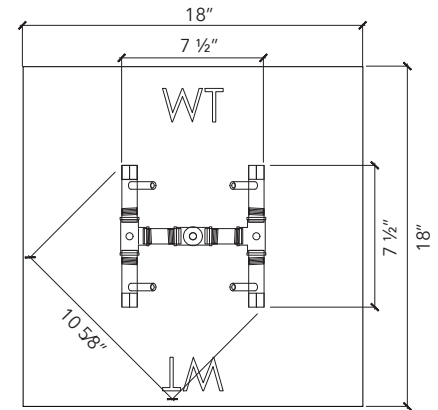
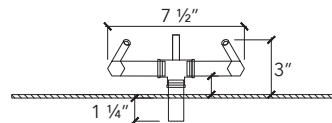

## ORIGINAL CFB84

For 18" opening or larger

SKU (NG OR LP)	DESCRIPTION	SHIP WEIGHT	SHIP DIMENSIONS
CFB84NG   CFB84LP	84K BTU Original Brass Burner	4 lbs	11" x 11" x 5"
Recommended parts: Plate: ALPL18S (square) • 3/4" Flex Line Kit • Optional 3x Support Collars			
CFB84NGALPL18S CFB84LPALPL18S	with 18" Square Plate	8 lbs	21" x 21" x 7"
CFB84NGALPL18SFK1 CFB84LPALPL18SFK1	with 18" Square Plate + 3/4" Flex Line Kit	11 lbs	21" x 21" x 7"
Compatible Ignition Systems: Push Button, 3 Volt, 24 Volt Spark Ignition, 24 Volt Hot Surface Ignition (SC)			

**SKU BREAKDOWN** **CFB O 360 NG ALPL 42C FK2**

C: CROSSFIRE Brass Burner  
 F: Flex Line Kit  
 B: BTU  
 O: Octagonal (Burner Type)  
 3: 360  
 6: 60  
 0: 0  
 N: NG  
 G: Gas Type  
 A: Plate or Pan  
 L: Shape of Plate  
 P: Plate  
 4: 4  
 2: 2  
 C: Shape of Plate  
 F: Flex Line Kit  
 K: 2  
 2: 2

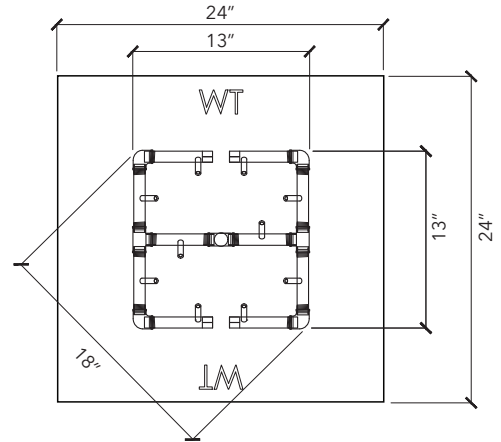
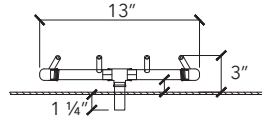
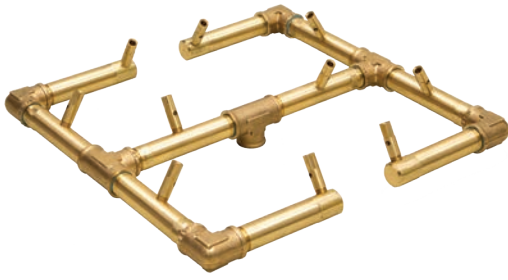

**ORIGINAL CFB120**  
For 24" opening or larger

SKU (NG OR LP)	DESCRIPTION	SHIP WEIGHT	SHIP DIMENSIONS
CFB120NG   CFB120LP	120K BTU Original Brass Burner	8 lbs	15" x 15" x 5"
Recommended parts: Plate: ALPL24S (square) • 3/4" Flex Line Kit • Optional 4x Support Collars			
CFB120NGALPL24S CFB120LPALPL24S	with 24" Square Plate	15 lbs	26" x 26" x 6"
CFB120NGALPL24SFK1 CFB120LPALPL24SFK1	with 24" Square Plate + 3/4" Flex Line Kit	18 lbs	26" x 26" x 6"
Compatible Ignition Systems: Push Button, 3 Volt, 24 Volt Spark Ignition, 24 Volt Hot Surface Ignition (SC)			

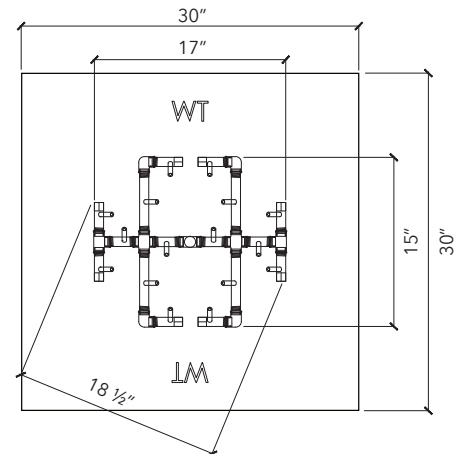
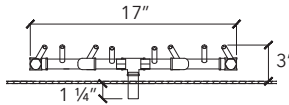
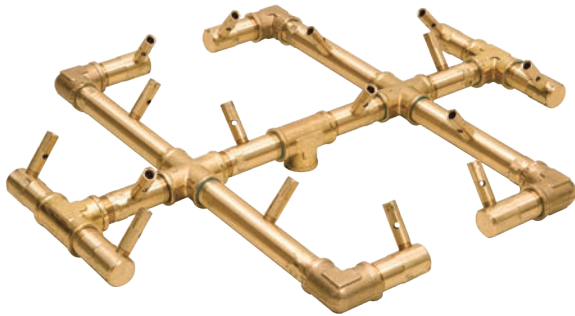

**ORIGINAL CFB180**  
For 30" opening or larger

SKU (NG OR LP)	DESCRIPTION	SHIP WEIGHT	SHIP DIMENSIONS
CFB180NG   CFB180LP	180K BTU Original Brass Burner	9 lbs	19" x 19" x 7"
Recommended parts: Plate: ALPL30S (square) • 3/4" Flex Line Kit • Optional 5x Support Collars			
CFB180NGALPL30S CFB180LPALPL30S	with 30" Square Plate	19 lbs	33" x 33" x 9"
CFB180NGALPL30SFK1 CFB180LPALPL30SFK1	with 30" Square Plate + 3/4" Flex Line Kit	22 lbs	33" x 33" x 9"
Compatible Ignition Systems: Push Button, 24 Volt Spark Ignition, 24 Volt Hot Surface Ignition (SC)			

**PLATE AND PAN OPTIONS ON PAGE 44**



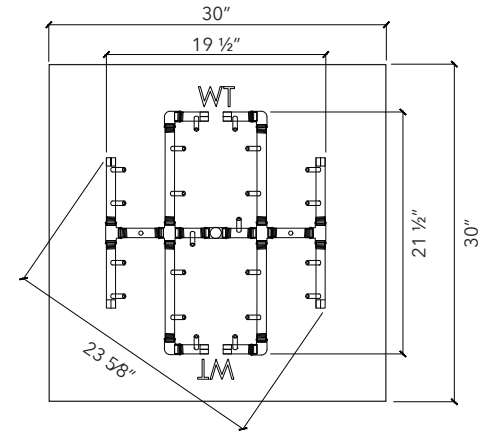
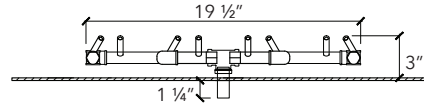

## ORIGINAL CFB240

For 30" opening or larger

SKU (NG OR LP)	DESCRIPTION	SHIP WEIGHT	SHIP DIMENSIONS
CFB240NG   CFB240LP	240K BTU Original Brass Burner	12 lbs	23" x 23" x 7"
Recommended parts: Plate: ALPL30S (square) • 3/4" Flex Line Kit • Optional 5x Support Collars			
CFB240NGALPL30S CFB240LPALPL30S	with 30" Square Plate	20 lbs	33" x 33" x 9"
CFB240NGALPL30SFK1 CFB240LPALPL30SFK1	with 30" Square Plate + 3/4" Flex Line Kit	23 lbs	33" x 33" x 9"
Compatible Ignition Systems: Push Button, 24 Volt Spark Ignition, 24 Volt Hot Surface Ignition (SC)			

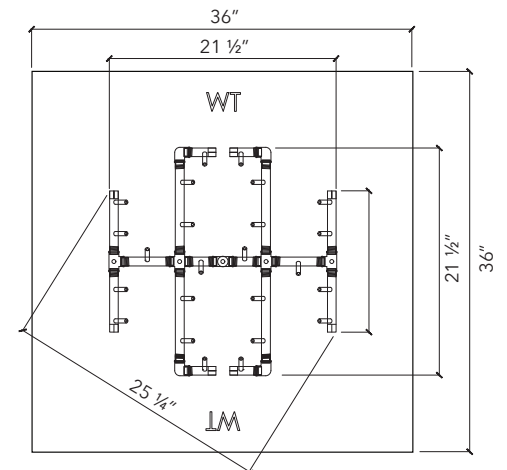
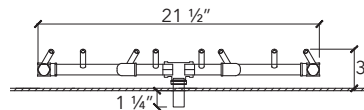
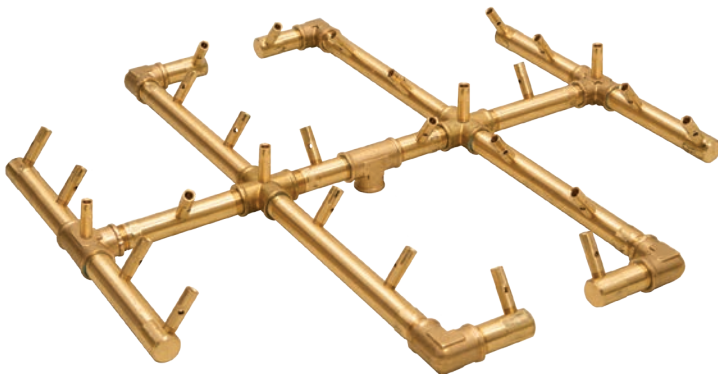

## ORIGINAL CFB290

For 36" opening or larger

SKU (NG OR LP)	DESCRIPTION	SHIP WEIGHT	SHIP DIMENSIONS
CFB290NG   CFB290LP	290K BTU Original Brass Burner	12 lbs	23" x 23" x 7"
Recommended parts: Plate: ALPL36S (square) • 3/4" Dual Flex Line Kit • Optional 6x Support Collars			
CFB290NGALPL36S CFB290LPALPL36S	with 36" Square Plate		SHIPS FREIGHT
CFB290NGALPL36SFK2 CFB290LPALPL36SFK2	with 36" Square Plate + 3/4" Dual Flex Line Kit		SHIPS FREIGHT
Compatible Ignition Systems: Push Button, 24 Volt Spark Ignition, 24 Volt Hot Surface Ignition (SC)			

**SKU BREAKDOWN**

CROSSFIRE Brass Burner	BTU	Plate or Pan	Shape of Plate	Flex Line Kit
<b>C</b>	<b>F</b>	<b>B</b>	<b>O</b>	<b>3</b>
<b>6</b>	<b>0</b>	<b>N</b>	<b>G</b>	<b>A</b>
<b>L</b>	<b>P</b>	<b>L</b>	<b>4</b>	<b>2</b>
<b>C</b>	<b>F</b>	<b>K</b>	<b>2</b>	

Octagonal (Burner Type)    Gas Type    Size of Plate    Flex Line Kit  
 360    NG    ALPL    42C    FK2

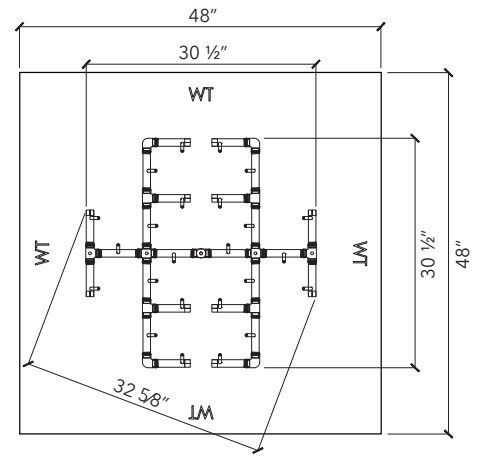
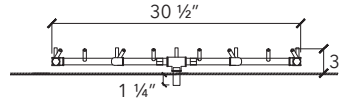
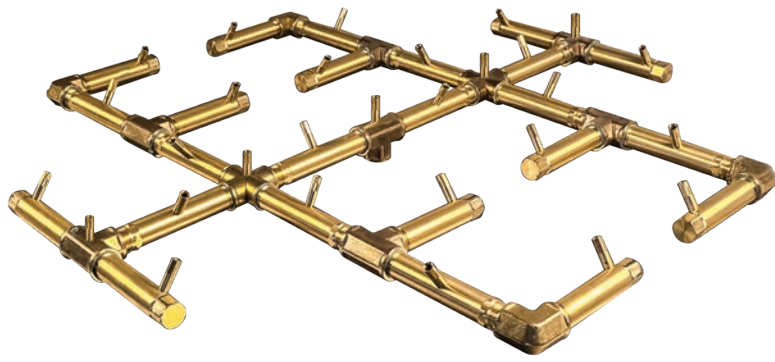

## ORIGINAL CFB350

For 48" opening or larger

SKU (NG OR LP)

DESCRIPTION

SHIP WEIGHT

SHIP DIMENSIONS

CFB350NG   CFB350LP	350K BTU Original Brass Burner	23 lbs	33" x 33" x 9"
Recommended parts: Plate: ALPL48S (square) • 3/4" Dual Flex Line Kit • Optional 8x Support Collars			
CFB350NGALPL48S CFB350LPALPL48S	with 48" Square Plate		SHIPS FREIGHT
CFB350NGALPL48SFK2 CFB350LPALPL48SFK2	with 48" Square Plate + 3/4" Dual Flex Line Kit		SHIPS FREIGHT
Compatible Ignition Systems: 24 Volt Spark Ignition, 24 Volt Hot Surface Ignition (HC)			

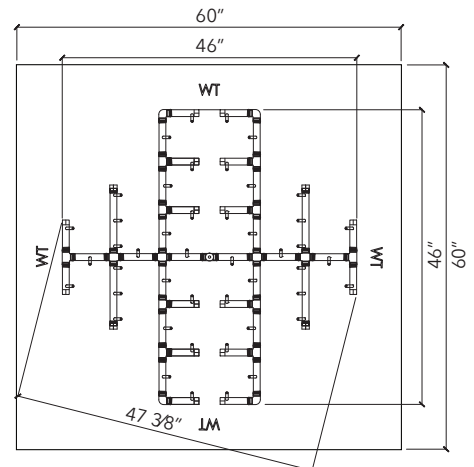
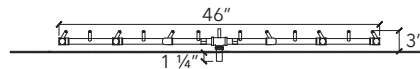

## ORIGINAL CFB450

For 60" opening or larger

SKU (NG OR LP)

DESCRIPTION

SHIP WEIGHT

SHIP DIMENSIONS

CFB450NG   CFB450LP	450K BTU Original Brass Burner		SHIPS FREIGHT
Recommended parts: Plate: ALPL60S (square) • 3/4" Dual Flex Line Kit • Optional 10x Support Collars			
CFB450NGALPL60S CFB450LPALPL60S	with 60" Square Plate		SHIPS FREIGHT
CFB450NGALPL60SFK2 CFB450LPALPL60SFK2	with 60" Square Plate + 3/4" Dual Flex Line Kit		SHIPS FREIGHT
Compatible Ignition Systems: 24 Volt Spark Ignition, 24 Volt Hot Surface Ignition (HC)			

**LIGHT IT UP! IGNITION SYSTEMS START ON PAGE 61**

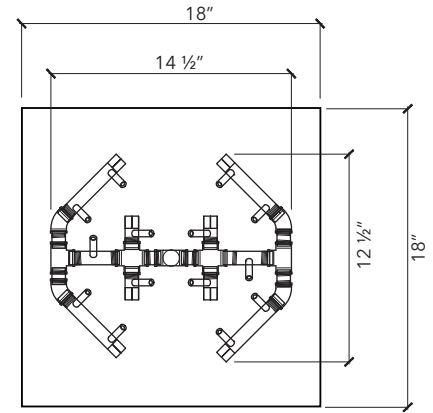
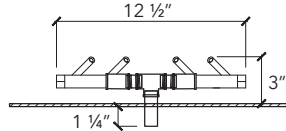

## OCTAGONAL CFBO140

For 18" opening or larger

SKU (NG OR LP)	DESCRIPTION	SHIP WEIGHT	SHIP DIMENSIONS
CFBO140NG   CFBO140LP	140K BTU Octagonal Brass Burner	9 lbs	19" x 15" x 5"
Recommended parts: Plate: ALPL18S (square) • 3/4" Flex Line Kit • Optional 3x Support Collars			
CFBO140NGALPL18S CFBO140LPALPL18S	with 18" Square Plate	13 lbs	20" x 20" x 6"
CFBO140NGALPL18SFK1 CFBO140LPALPL18SFK1	with 18" Square Plate + 3/4" Flex Line Kit	16 lbs	20" x 20" x 6"
Compatible Ignition Systems: Push Button, 24 Volt Spark Ignition, 24 Volt Hot Surface Ignition (SC)			

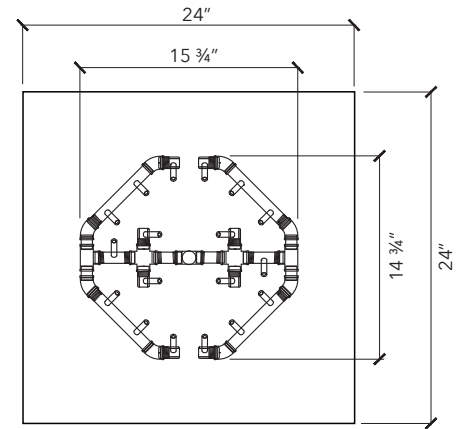
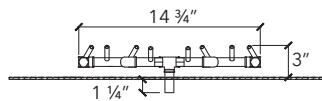
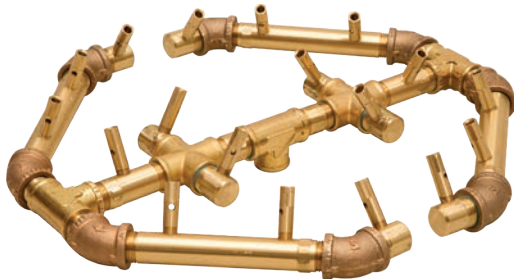

## OCTAGONAL CFBO180

For 24" opening or larger

SKU (NG OR LP)	DESCRIPTION	SHIP WEIGHT	SHIP DIMENSIONS
CFBO180NG   CFBO180LP	180K BTU Octagonal Brass Burner	10 lbs	19" x 15" x 5"
Recommended parts: Plate: ALPL24S (square) • 3/4" Flex Line Kit • Optional 4x Support Collars			
CFBO180NGALPL24S CFBO180LPALPL24S	with 24" Square Plate	17 lbs	26" x 26" x 6"
CFBO180NGALPL24SFK1 CFBO180LPALPL24SFK1	with 24" Square Plate + 3/4" Flex Line Kit	20 lbs	26" x 26" x 6"
Compatible Ignition Systems: Push Button, 24 Volt Spark Ignition, 24 Volt Hot Surface Ignition (SC)			

**SKU BREAKDOWN**

CF	B	O	3	6	0	NG	AL	PL	4	2	C	FK	2
CROSSFIRE Brass Burner		BTU		Plate or Pan		Shape of Plate		Size of Plate		Flex Line Kit			



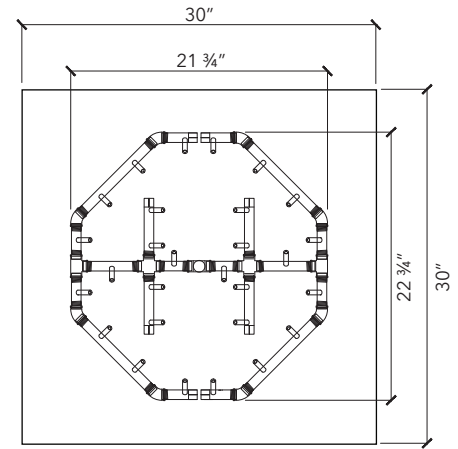
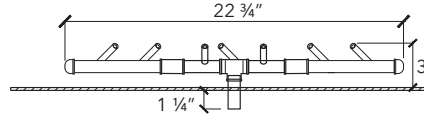
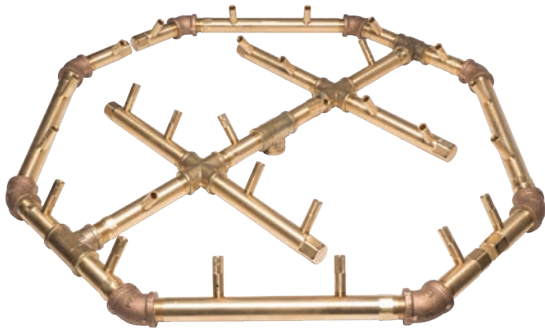

## OCTAGONAL CFBO280

For 30" opening or larger

SKU (NG OR LP)

DESCRIPTION

SHIP WEIGHT

SHIP DIMENSIONS

CFBO280NG   CFBO280LP	280K BTU Octagonal Brass Burner	13 lbs	25" x 25" x 7"
Recommended parts: Plate: ALPL30S (square) • 3/4" Dual Flex Line Kit • Optional 5x Support Collars			
CFBO280NGALPL30S CFBO280LPALPL30S	with 30" Square Plate	23 lbs	32" x 32" x 8"
CFBO280NGALPL30SFK2 CFBO280LPALPL30SFK2	with 30" Square Plate + 3/4" Dual Flex Line Kit	30 lbs	32" x 32" x 8"
Compatible Ignition Systems: Push Button, 24 Volt Spark Ignition, 24 Volt Hot Surface Ignition (HC)			

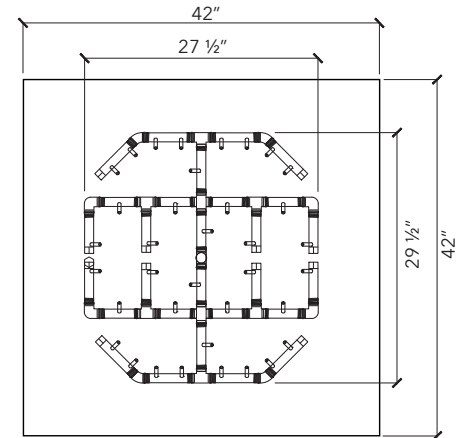
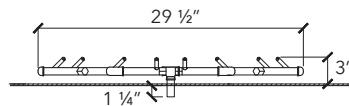
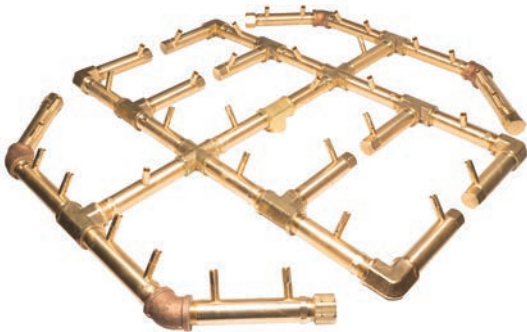

## OCTAGONAL CFBO360

For 42" opening or larger

SKU (NG OR LP)

DESCRIPTION

SHIP WEIGHT

SHIP DIMENSIONS

CFBO360NG   CFB360LP	360K BTU Octagonal Brass Burner	22 lbs	31" x 31" x 7"
Recommended parts: Plate: ALPL42S (square) • 3/4" Dual Flex Line Kit • Optional 7x Support Collars			
CFBO360NGALPL42S CFBO360LPALPL42S	with 42" Square Plate		SHIPS FREIGHT
CFBO360NGALPL42SFK2 CFBO360LPALPL42SFK2	with 42" Square Plate + 3/4" Dual Flex Line Kit		SHIPS FREIGHT
Compatible Ignition Systems: 24 Volt Spark Ignition, 24 Volt Hot Surface Ignition (HC)			

**FLEX LINE AND PARTS ON PAGE 65**

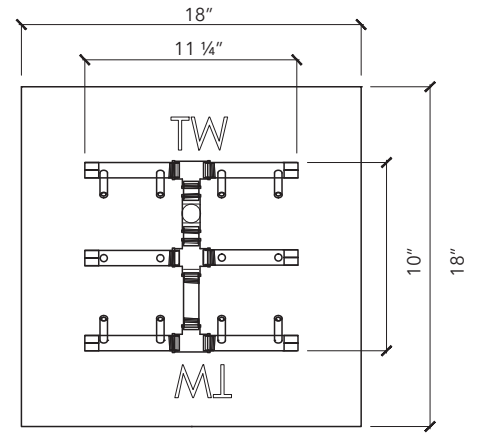
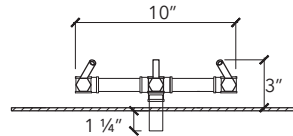

## SQUARE TREE-STYLE CFBST120

For 18" opening or larger

SKU (NG OR LP)

DESCRIPTION

SHIP WEIGHT

SHIP DIMENSIONS

CFBST120NG   CFBST120LP	120K BTU Square Tree-Style Brass Burner	6 lbs	13" x 13" x 5"
Recommended parts: Plate: ALPL18S (square) • 3/4" Flex Line Kit • Optional 4x Support Collars			
CFBST120NGALPL18S CFBST120LPALPL18S	with 18" Square Plate	13 lbs	21" x 21" x 7"
CFBST120NGALPL18SFK1 CFBST120LPALPL18SFK1	with 18" Square Plate + 3/4" Flex Line Kit	15 lbs	21" x 21" x 7"
Compatible Ignition Systems: Push Button, 3 Volt, 24 Volt Spark Ignition, 24 Volt Hot Surface Ignition (SC)			

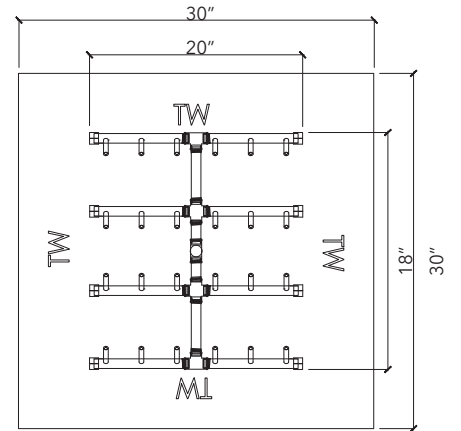
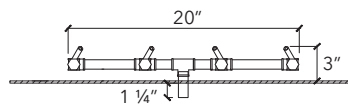

## SQUARE TREE-STYLE CFBST240

For 30" opening or larger

SKU (NG OR LP)

DESCRIPTION

SHIP WEIGHT

SHIP DIMENSIONS

CFBST240NG   CFBST240LP	240K BTU Square Tree-Style Brass Burner	11 lbs	21" x 21" x 7"
Recommended parts: Plate: ALPL30S (square) • 3/4" Flex Line Kit • Optional 4x Support Collars			
CFBST240NGALPL30S CFBST240LPALPL30S	with 30" Square Plate	25 lbs	33" x 33" x 7"
CFBST240NGALPL30SFK1 CFBST240LPALPL30SFK1	with 30" Square Plate + 3/4" Flex Line Kit	27 lbs	33" x 33" x 7"
Compatible Ignition Systems: Push Button, 24 Volt Spark Ignition, 24 Volt Hot Surface Ignition (SC)			

**SKU BREAKDOWN** **C F B O 3 6 0 N G A L P L 4 2 C F K 2**

	Octagonal (Burner Type)	Gas Type	Size of Plate	Flex Line Kit
CROSSFIRE Brass Burner	BTU	Plate or Pan	Shape of Plate	

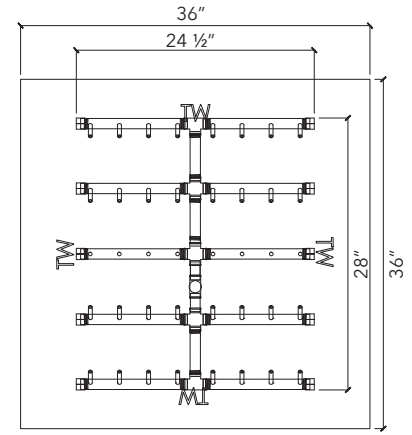
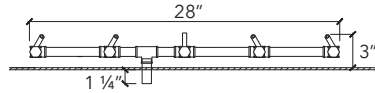

## SQUARE TREE-STYLE CFBST400

For 36" opening or larger

SKU (NG OR LP)	DESCRIPTION	SHIP WEIGHT	SHIP DIMENSIONS
CFBST400NG   CFBST400LP	400K BTU Square Tree-Style Brass Burner	18 lbs	29" x 29" x 7"
Recommended parts: Plate: ALPL36S (square) • 3/4" Dual Flex Line Kit • Optional 4x Support Collars			
CFBST400NGALPL36S CFBST400LPALPL36S	with 36" Square Plate	37 lbs	38" x 38" x 6"
CFBST400NGALPL36SFK2 CFBST400LPALPL36SFK2	with 36" Square Plate + 3/4" Dual Flex Line Kit	40 lbs	38" x 38" x 6"
Compatible Ignition Systems: 24 Volt Spark Ignition, 24 Volt Hot Surface Ignition (HC)			

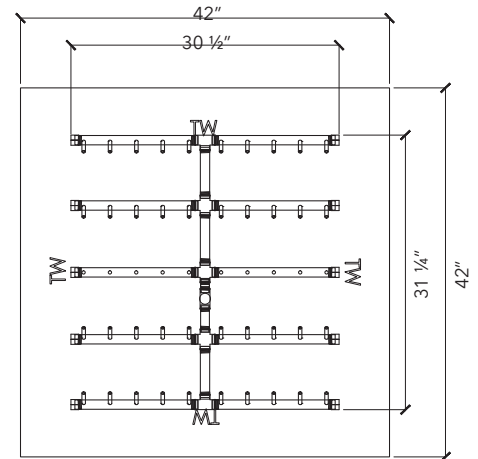
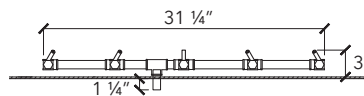
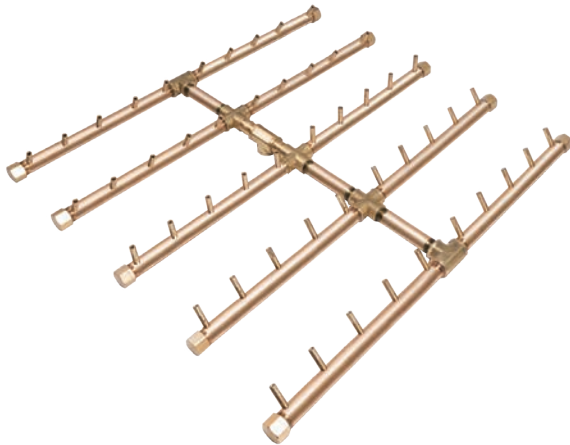

## SQUARE TREE-STYLE CFBST500

For 42" opening or larger

SKU (NG OR LP)	DESCRIPTION	SHIP WEIGHT	SHIP DIMENSIONS
CFBST500NG   CFBST500LP	500K BTU Square Tree-Style Brass Burner	22 lbs	33" x 33" x 9"
Recommended parts: Plate: ALPL42S (square) • 3/4" Dual Flex Line Kit • Optional 7x Support Collars			
CFBST500NGALPL42S CFBST500LPALPL42S	with 42" Square Plate		SHIPS FREIGHT
CFBST500NGALPL42SFK2 CFBST500LPALPL42SFK2	with 42" Square Plate + 3/4" Dual Flex Line Kit		SHIPS FREIGHT
Compatible Ignition Systems: 24 Volt Hot Surface Ignition (HC)			

COMPLETE THE FEATURE WITH MEDIA, PAGE 66





So good at making  
dreams come true you'd  
think we were the fairy  
godmother of fire.

Let us create the custom  
fire feature of your dreams.

Call us today. We'd love to help. 877 556 5255





## OPTIONS FOR RECTANGULAR OPENINGS & FIREPLACES

---

Designed for rectangular fire features and outdoor fireplaces, these CROSSFIRE® Brass Burners range from 90K to 480K BTUs.

Need a different size or shape? We're happy to help. Call our Flame Consultants at 877 556 5255

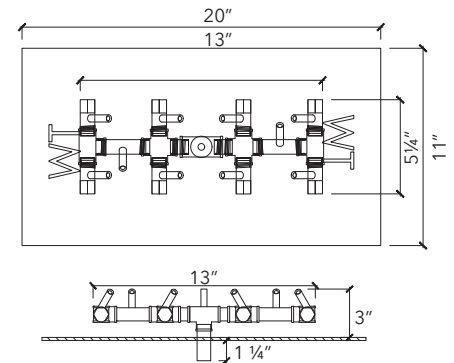

### TREE-STYLE CFBT110

For 20" x 11" opening or larger

SKU (NG OR LP)	DESCRIPTION	SHIP WEIGHT	SHIP DIMENSIONS
CFBT110NG   CFBT110LP	110K BTU Tree-Style Brass Burner	6 lbs	15" x 15" x 5"
Recommended parts: Plate: ALPL2011 • 3/4" Flex Line Kit • Optional 3x Support Collars			
CFBT110NGALPL2011 CFBT110LPALPL2011	with 20" x 11" Rectangular Plate	12 lbs	21" x 21" x 7"
CFBT110NGALPL2011FK1 CFBT110LPALPL2011FK1	with 20" x 11" Plate + 3/4" Flex Line Kit	15 lbs	21" x 21" x 7"
Compatible Ignition Systems: Push Button, 3 Volt, 24 Volt Spark Ignition, 24 Volt Hot Surface Ignition (SC)			

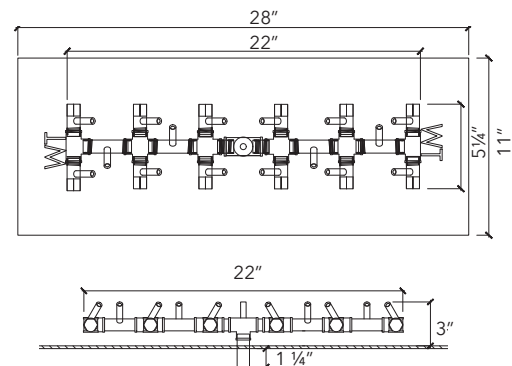

### TREE-STYLE CFBT170

For 28" x 11" opening or larger

SKU (NG OR LP)	DESCRIPTION	SHIP WEIGHT	SHIP DIMENSIONS
CFBT170NG   CFBT170LP	170K BTU Tree-Style Brass Burner	8 lbs	25" x 9" x 7"
Recommended parts: Plate: ALPL2811 • 3/4" Flex Line Kit • Optional 4x Support Collars			
CFBT170NGALPL2811 CFBT170LPALPL2811	with 28" x 11" Rectangular Plate	16 lbs	37" x 13" x 13"
CFBT170NGALPL2811FK1 CFBT170LPALPL2811FK1	with 28" x 11" Plate + 3/4" Flex Line Kit	15 lbs	37" x 13" x 13"
Compatible Ignition Systems: Push Button, 24 Volt Spark Ignition, 24 Volt Hot Surface Ignition (SC)			

**SKU BREAKDOWN** **C F B O 3 6 0 N G A L P L 4 2 C F K 2**

	Octagonal (Burner Type)	Gas Type	Size of Plate	Flex Line Kit
C	O	N	A	F
F	B	G	L	K
B	3	6	4	2
O	0	0	2	C
3	6	0	4	2
0	N	G	A	L
N	G	A	L	P
G	A	L	P	L
A	L	P	L	4
L	P	L	4	2
4	2	C	F	K
2	C	F	K	2
4	2	C	F	K
2	C	F	K	2
C	F	K	2	
F	K	2		
K	2			
2				

CROSSFIRE Brass Burner    BTU    Plate or Pan    Shape of Plate

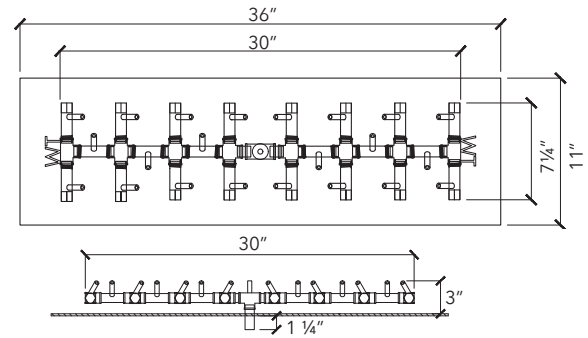

## TREE-STYLE CFBT230

For 36" x 11" opening or larger

SKU (NG OR LP)	DESCRIPTION	SHIP WEIGHT	SHIP DIMENSIONS
CFBT230NG   CFBT230LP	230K BTU Tree-Style Brass Burner	10 lbs	37" x 13" x 13"
Recommended parts: Plate: ALPL3611 • 3/4" Flex Line Kit • Optional 5x Support Collars			
CFBT230NGALPL3611 CFBT230LPALPL3611	with 36" x 11" Rectangular Plate	19 lbs	37" x 13" x 13"
CFBT230NGALPL3611FK1 CFBT230LPALPL3611FK1	with 36" x 11" Plate + 3/4" Flex Line Kit	22 lbs	37" x 13" x 13"
Compatible Ignition Systems: Push Button, 24 Volt Spark Ignition, 24 Volt Hot Surface Ignition (SC)			

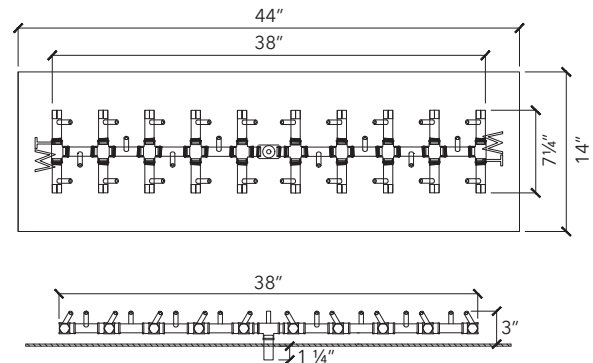

## TREE-STYLE CFBT290

For 44" x 14" opening or larger

SKU (NG OR LP)	DESCRIPTION	SHIP WEIGHT	SHIP DIMENSIONS
CFBT290NG   CFBT290LP	290K BTU Tree-Style Brass Burner	12 lbs	49" x 9" x 9"
Recommended parts: Plate: ALPL4414 • 3/4" Dual Flex Line Kit • Optional 5x Support Collars			
CFBT290NGALPL4414 CFBT290LPALPL4414	with 44" x 14" Rectangular Plate	30 lbs	49" x 17" x 17"
CFBT290NGALPL4414FK2 CFBT290LPALPL4414FK2	with 44" x 14" Plate + 3/4" Dual Flex Line Kit	37 lbs	49" x 17" x 17"
Compatible Ignition Systems: Push Button, 24 Volt Spark Ignition, 24 Volt Hot Surface Ignition (SC)			

**PLATE AND PAN OPTIONS ON PAGE 44**



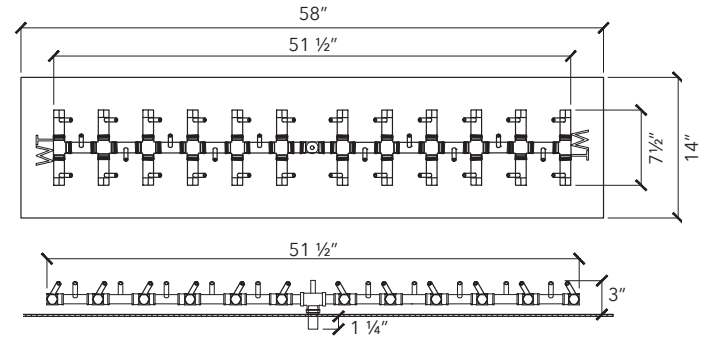
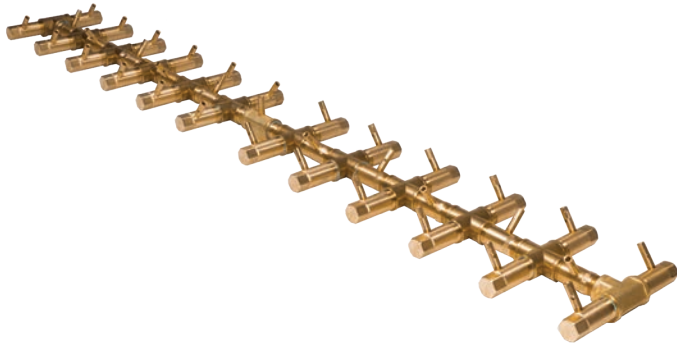

**TREE-STYLE CFBT350**  
For 58" x 14" opening or larger

SKU (NG OR LP)	DESCRIPTION	SHIP WEIGHT	SHIP DIMENSIONS
CFBT350NG   CFBT350LP	350K BTU Tree-Style Brass Burner	20 lbs	61" x 9" x 9"
Recommended parts: Plate: ALPL5814 • 3/4" Dual Flex Line Kit • Optional 7x Support Collars			
CFBT350NGALPL5814 CFBT350LPALPL5814	with 58" x 14" Rectangular Plate	SHIPS FREIGHT	
CFBT350NGALPL5814FK2 CFBT350LPALPL5814FK2	with 58" x 14" Plate + 3/4" Dual Flex Line Kit	SHIPS FREIGHT	
Compatible Ignition Systems: 24 Volt Hot Surface Ignition (HC)			

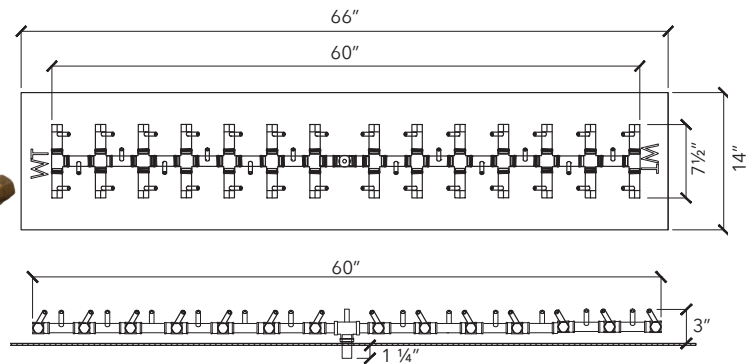
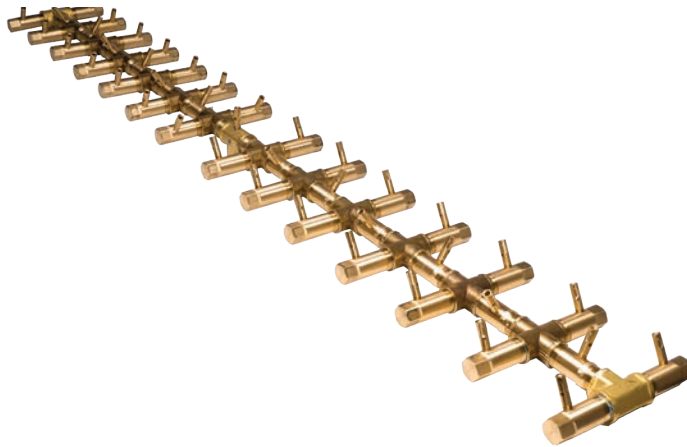

**TREE-STYLE CFBT410**  
For 66" x 14" opening or larger

SKU (NG OR LP)	DESCRIPTION	SHIP WEIGHT	SHIP DIMENSIONS
CFBT410NG   CFBT410LP	410K BTU Tree-Style Brass Burner	20 lbs	61" x 61" x 9"
Recommended parts: Plate: ALPL6614 • 3/4" Dual Flex Line Kit • Optional 8x Support Collars			
CFBT410NGALPL6614 CFBT410LPALPL6614	with 66" x 14" Rectangular Plate	SHIPS FREIGHT	
CFBT410NGALPL6614FK2 CFBT410LPALPL6614FK2	with 66" x 14" Plate + 3/4" Dual Flex Line Kit	SHIPS FREIGHT	
Compatible Ignition Systems: 24 Volt Hot Surface Ignition (HC)			

**SKU BREAKDOWN** **C F B O 3 6 0 N G A L P L 4 2 C F K 2**

Octagonal (Burner Type)    Gas Type    Size of Plate    Flex Line Kit  
 CROSSFIRE Brass Burner    BTU    Plate or Pan    Shape of Plate

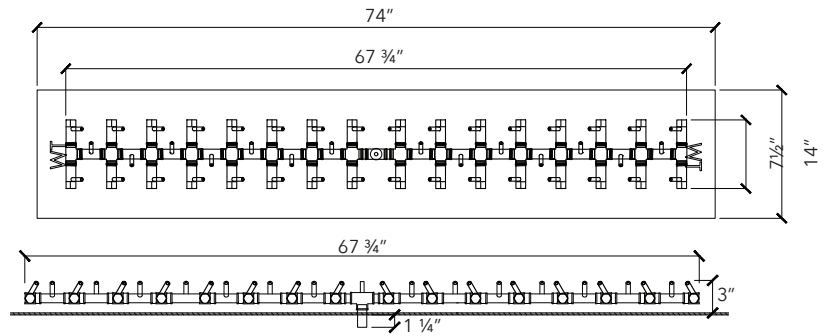
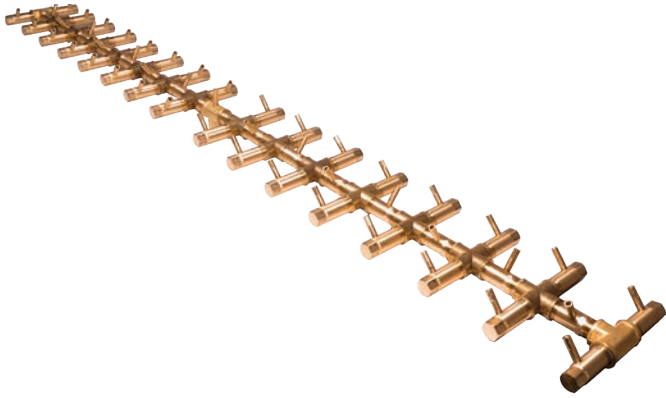

## TREE-STYLE CFBT470

For 74" x 14" opening or larger

SKU (NG OR LP)

DESCRIPTION

SHIP WEIGHT

SHIP DIMENSIONS

CFBT470NG | CFBT470LP

470K BTU Tree-Style Brass Burner

SHIPS FREIGHT

Recommended parts: Plate: ALPL7414 • 3/4" Dual Flex Line Kit • Optional 9x Support Collars

CFBT470NGALPL7414  
CFBT470LPALPL7414

with 74" x 14" Rectangular Plate

SHIPS FREIGHT

CFBT470NGALPL7414FK2  
CFBT470LPALPL7414FK2

with 74" x 14" Plate + 3/4" Dual Flex Line Kit

SHIPS FREIGHT

Compatible Ignition Systems: 24 Volt Hot Surface Ignition (HC)

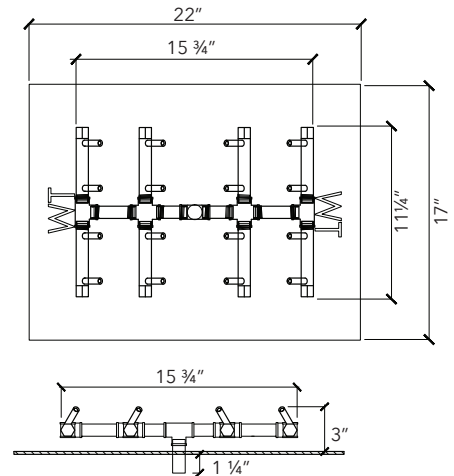

## DOUBLE TREE-STYLE CFBDT160

For 22" x 17" opening or larger

SKU (NG OR LP)

DESCRIPTION

SHIP WEIGHT

SHIP DIMENSIONS

CFBDT160NG | CFBDT160LP

160K BTU Double Tree-Style Brass Burner

8 lbs

19" x 15" x 5"

Recommended parts: Plate: ALPL2217 • 3/4" Flex Line Kit • Optional 4x Support Collars

CFBDT160NGALPL2217  
CFBDT160LPALPL2217

with 22" x 17" Rectangular Plate

12 lbs

19" x 15" x 5"

CFBDT160NGALPL2217FK1  
CFBDT160LPALPL2217FK1

with 22" x 17" Plate + 3/4" Flex Line Kit

15 lbs

25" x 25" x 7"

Compatible Ignition Systems: Push Button, 24 Volt Spark Ignition, 24 Volt Hot Surface Ignition (SC)

**LIGHT IT UP! IGNITION SYSTEMS START ON PAGE 61**

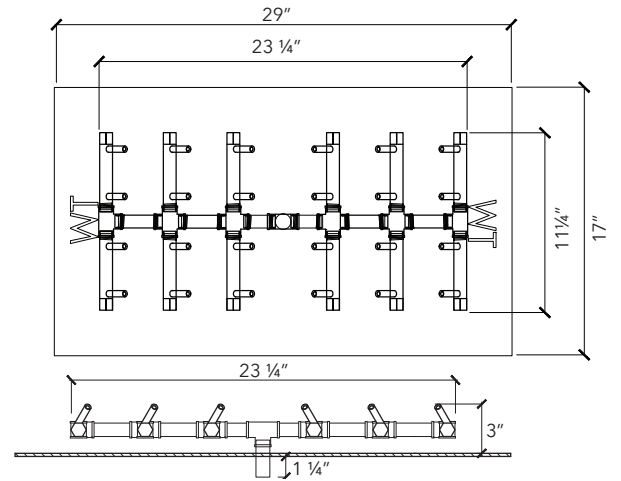
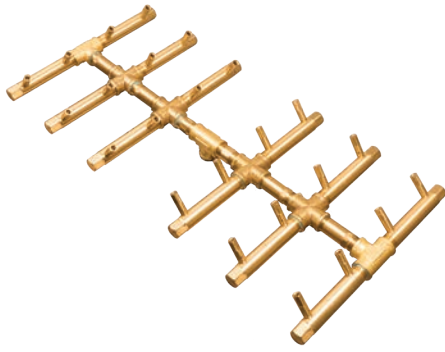

## DOUBLE TREE-STYLE CFBDT240

For 29" x 17" opening or larger

SKU (NG OR LP)	DESCRIPTION	SHIP WEIGHT	SHIP DIMENSIONS
CFBDT240NG   CFBDT240LP	240K BTU Double Tree-Style Brass Burner	11 lbs	25" x 25" x 7"
Recommended parts: Plate: ALPL2917 • 3/4" Flex Line Kit • Optional 5x Support Collars			
CFBDT240NGALPL2917 CFBDT240LPALPL2917	with 29" x 17" Rectangular Plate	18 lbs	31" x 31" x 7"
CFBDT240NGALPL2917FK1 CFBDT240LPALPL2917FK1	with 29" x 17" Plate + 3/4" Flex Line Kit	21 lbs	31" x 31" x 7"
Compatible Ignition Systems: Push Button, 24 Volt Spark Ignition, 24 Volt Hot Surface Ignition (SC)			

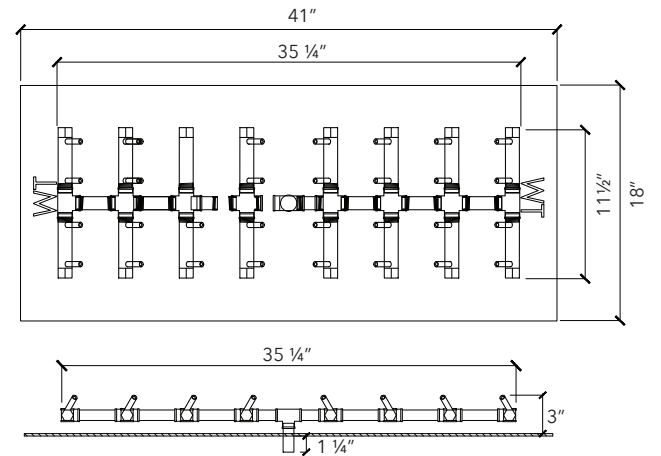
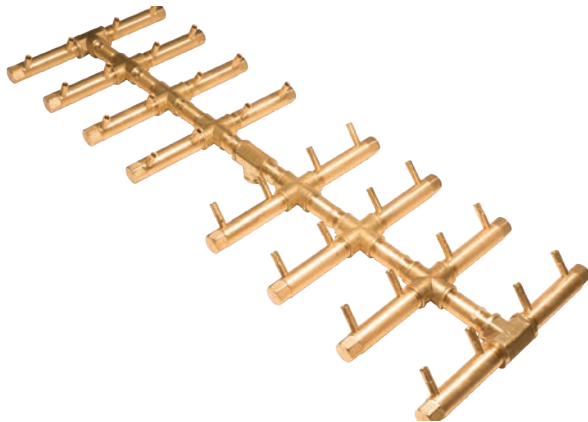

## DOUBLE TREE-STYLE CFBDT320

For 41" x 18" opening or larger

SKU (NG OR LP)	DESCRIPTION	SHIP WEIGHT	SHIP DIMENSIONS
CFBDT320NG   CFBDT320LP	320K BTU Double Tree-Style Brass Burner	18 lbs	37" x 13" x 13"
Recommended parts: Plate: ALPL4118 • 3/4" Dual Flex Line Kit • Optional 6x Support Collars			
CFBDT320NGALPL4118 CFBDT320LPALPL4118	with 41" x 18" Rectangular Plate		SHIPS FREIGHT
CFBDT320NGALPL4118FK2 CFBDT320LPALPL4118FK2	with 41" x 18" Plate + 3/4" Dual Flex Line Kit		SHIPS FREIGHT
Compatible Ignition Systems: 24 Volt Spark Ignition, 24 Volt Hot Surface Ignition (HC)			

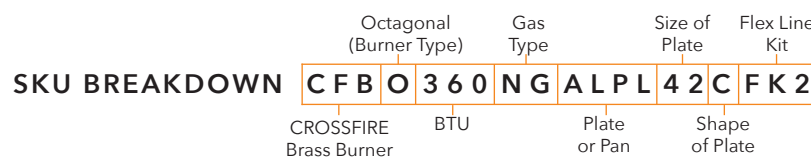

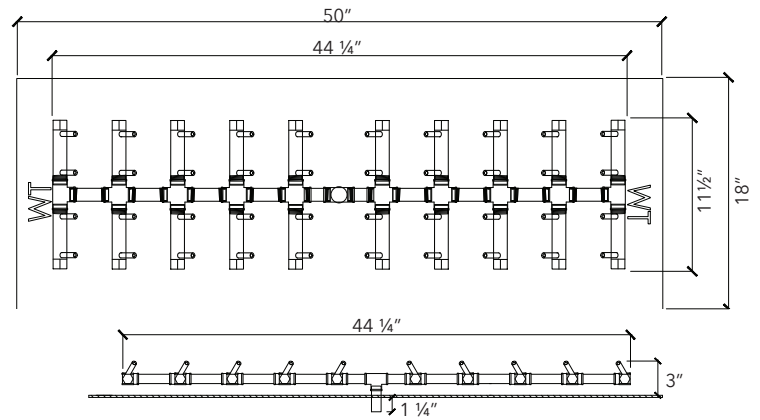

## DOUBLE TREE-STYLE CFBDT400

For 50" x 18" opening or larger

SKU (NG OR LP)	DESCRIPTION	SHIP WEIGHT	SHIP DIMENSIONS
CFBDT400NG   CFBDT400LP	400K BTU Double Tree-Style Brass Burner	22 lbs	49" x 9" x 9"
Recommended parts: Plate: ALPL5018 • 3/4" Dual Flex Line Kit • Optional 7x Support Collars			
CFBDT400NGALPL5018 CFBDT400LPALPL5018	with 50" x 18" Rectangular Plate	SHIPS FREIGHT	
CFBDT400NGALPL5018FK2 CFBDT400LPALPL5018FK2	with 50" x 18" Plate + 3/4" Dual Flex Line Kit	SHIPS FREIGHT	
Compatible Ignition Systems: 24 Volt Spark Ignition, 24 Volt Hot Surface Ignition (HC)			

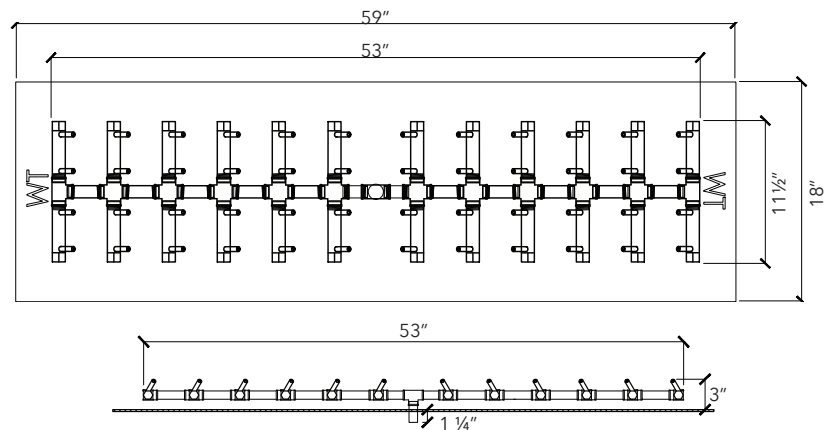
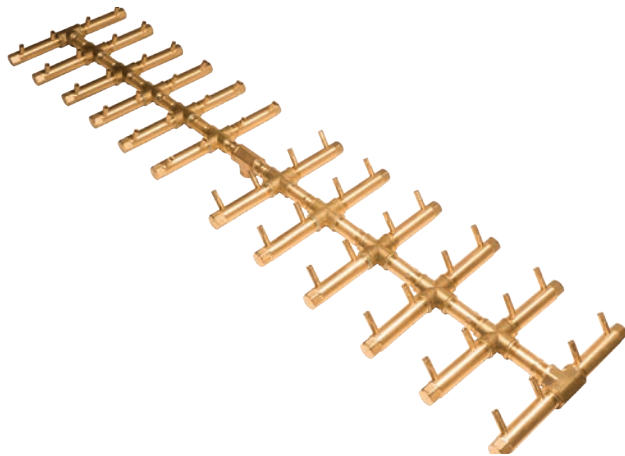

## DOUBLE TREE-STYLE CFBDT480

For 59" x 18" opening or larger

SKU (NG OR LP)	DESCRIPTION	SHIP WEIGHT	SHIP DIMENSIONS
CFBDT480NG   CFBDT480LP	480K BTU Double Tree-Style Brass Burner	28 lbs	61" x 9" x 9"
Recommended parts: Plate: ALPL5918 • 3/4" Dual Flex Line Kit • Optional 7x Support Collars			
CFBDT480NGALPL5918 CFBDT480LPALPL5918	with 59" x 18" Rectangular Plate	SHIPS FREIGHT	
CFBDT480NGALPL5918FK2 CFBDT480LPALPL5918FK2	with 59" x 18" Plate + 3/4" Dual Flex Line Kit	SHIPS FREIGHT	
Compatible Ignition Systems: 24 Volt Spark Ignition, 24 Volt Hot Surface Ignition (HC)			

FLEX LINE AND PARTS ON PAGE 65



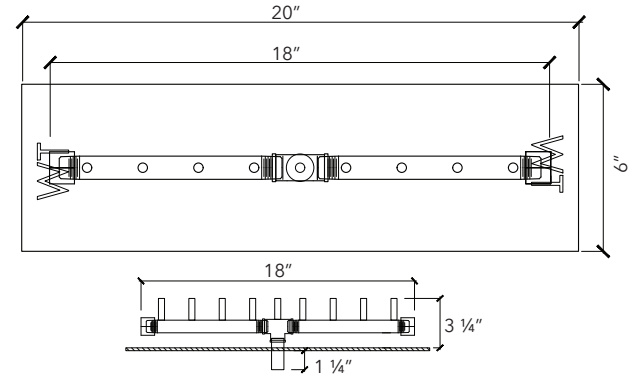
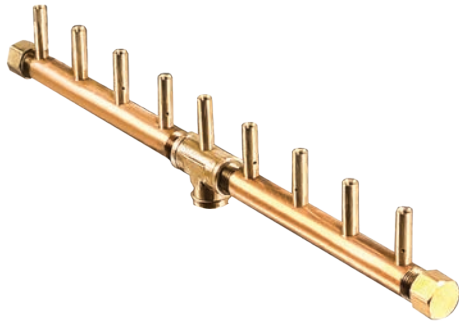

## LINEAR CFBL90

For 20" x 6" opening or larger

SKU (NG OR LP)	DESCRIPTION	SHIP WEIGHT	SHIP DIMENSIONS
CFBL90NG   CFBL90LP	90K BTU Linear Brass Burner	4 lbs	25" x 5" x 5"
Recommended parts: Plate: ALPL206 • 3/4" Flex Line Kit • Optional 3x Support Collars			
CFBL90NGALPL206 CFBL90LPALPL206	with 20" x 6" Rectangular Plate	7 lbs	25" x 9" x 7"
CFBL90NGALPL206FK1 CFBL90LPALPL206FK1	with 20" x 6" Plate + 3/4" Flex Line Kit	10 lbs	25" x 9" x 7"
Compatible Ignition Systems: Push Button, 3 Volt, 24 Volt Spark Ignition, 24 Volt Hot Surface Ignition (SC)			

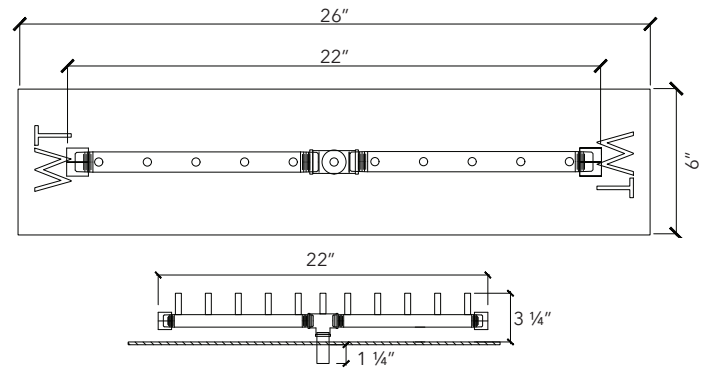
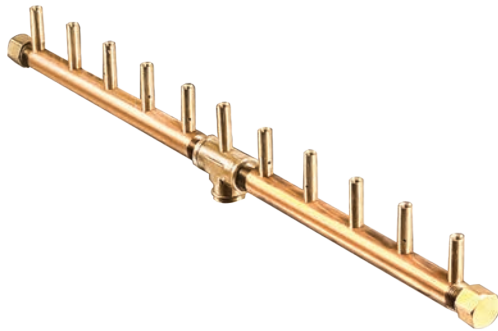

## LINEAR CFBL110

For 26" x 6" opening or larger

SKU (NG OR LP)	DESCRIPTION	SHIP WEIGHT	SHIP DIMENSIONS
CFBL110NG   CFBL110LP	110K BTU Linear Brass Burner	5 lbs	25" x 5" x 5"
Recommended parts: Plate: ALPL266 • 3/4" Flex Line Kit • Optional 3x Support Collars			
CFBL110NGALPL266 CFBL110LPALPL266	with 26" x 6" Rectangular Plate	10 lbs	31" x 7" x 7"
CFBL110NGALPL266FK1 CFBL110LPALPL266FK1	with 26" x 6" Plate + 3/4" Flex Line Kit	13 lbs	31" x 7" x 7"
Compatible Ignition Systems: Push Button, 3 Volt, 24 Volt Spark Ignition, 24 Volt Hot Surface Ignition (SC)			

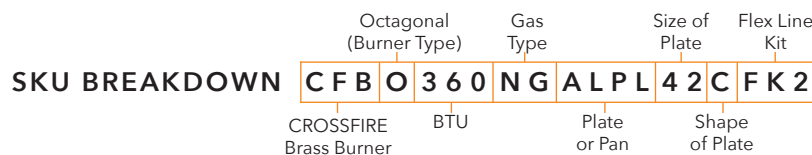

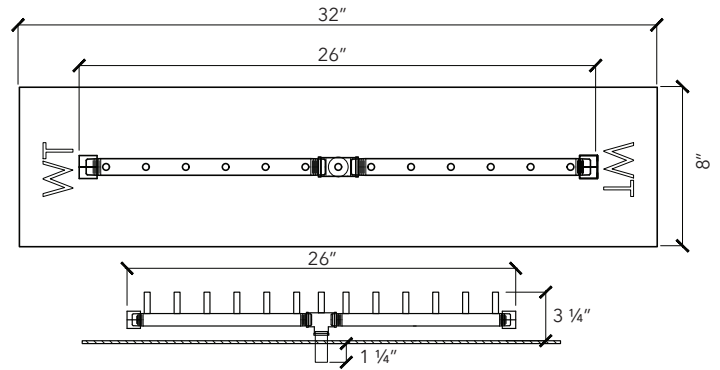
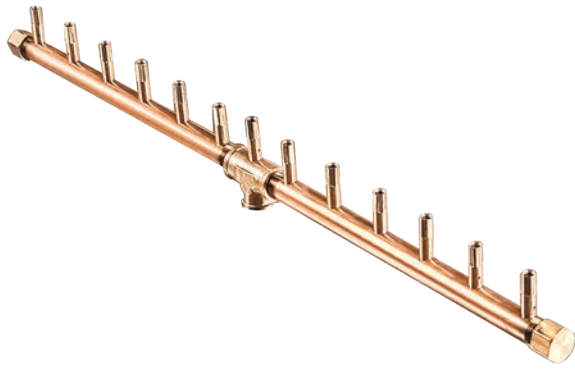

**LINEAR CFBL130**  
For 32" x 8" opening or larger

SKU (NG OR LP)	DESCRIPTION	SHIP WEIGHT	SHIP DIMENSIONS
CFBL130NG   CFBL130LP	130K BTU Linear Brass Burner	5 lbs	37" x 5" x 5"
Recommended parts: Plate: ALPL328 • 3/4" Flex Line Kit • Optional 4x Support Collars			
CFBL130NGALPL328 CFBL130LPALPL328	with 32" x 8" Rectangular Plate	11 lbs	37" x 13" x 13"
CFBL130NGALPL328FK1 CFBL130LPALPL328FK1	with 32" x 8" Plate + 3/4" Flex Line Kit	14 lbs	37" x 13" x 13"
Compatible Ignition Systems: Push Button, 24 Volt Spark Ignition, 24 Volt Hot Surface Ignition (SC)			

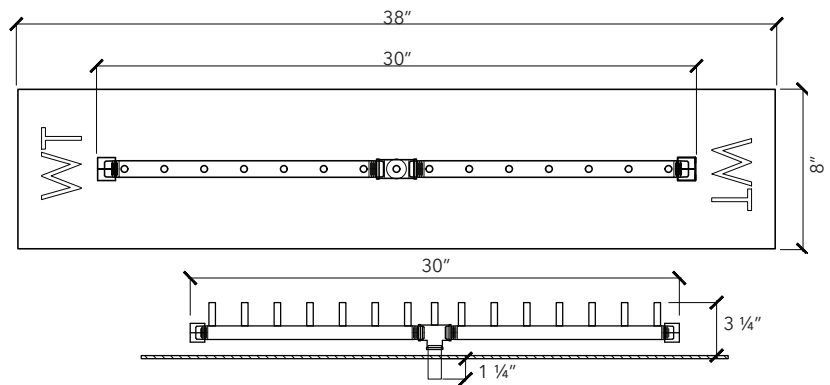
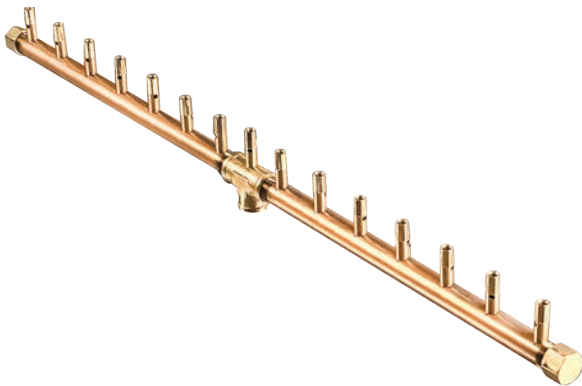

**LINEAR CFBL150**  
For 38" x 8" opening or larger

SKU (NG OR LP)	DESCRIPTION	SHIP WEIGHT	SHIP DIMENSIONS
CFBL150NG   CFBL150LP	150K BTU Linear Brass Burner	5 lbs	37" x 5" x 5"
Recommended parts: Plate: ALPL388 • 3/4" Flex Line Kit • Optional 4x Support Collars			
CFBL150NGALPL388 CFBL150LPALPL388	with 38" x 8" Rectangular Plate	14 lbs	41" x 9" x 9"
CFBL150NGALPL388FK1 CFBL150LPALPL388FK1	with 38" x 8" Plate + 3/4" Flex Line Kit	17 lbs	41" x 9" x 9"
Compatible Ignition Systems: Push Button, 24 Volt Spark Ignition, 24 Volt Hot Surface Ignition (SC)			

COMPLETE THE FEATURE WITH MEDIA, PAGE 66

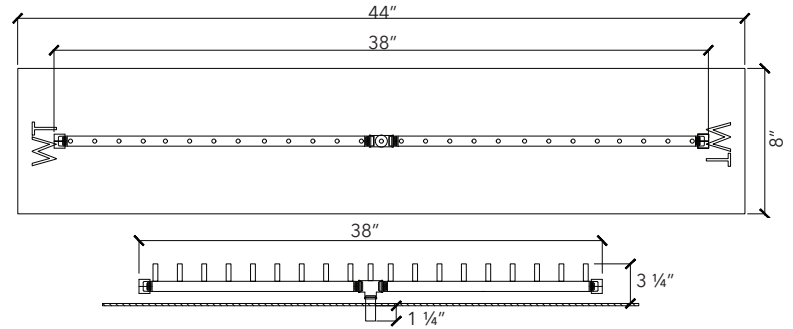
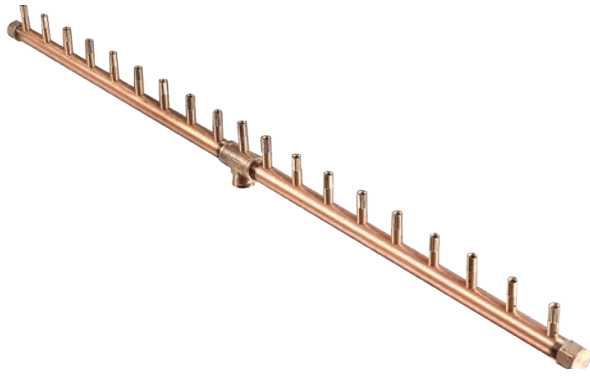

## LINEAR CFBL190

For 44" x 8" opening or larger

SKU (NG OR LP)	DESCRIPTION	SHIP WEIGHT	SHIP DIMENSIONS
CFBL190NG   CFBL190LP	190K BTU Linear Brass Burner	6 lbs	49" x 5" x 5"
Recommended parts: Plate: ALPL448 • 3/4" Flex Line Kit • Optional 5x Support Collars			
CFBL190NGALPL448 CFBL190LPALPL448	with 44" x 8" Rectangular Plate	17 lbs	49" x 9" x 9"
CFBL190NGALPL448FK1 CFBL190LPALPL448FK1	with 44" x 8" Plate + 3/4" Flex Line Kit	20 lbs	49" x 9" x 9"
Compatible Ignition Systems: Push Button, 24 Volt Spark Ignition, 24 Volt Hot Surface Ignition (SC)			

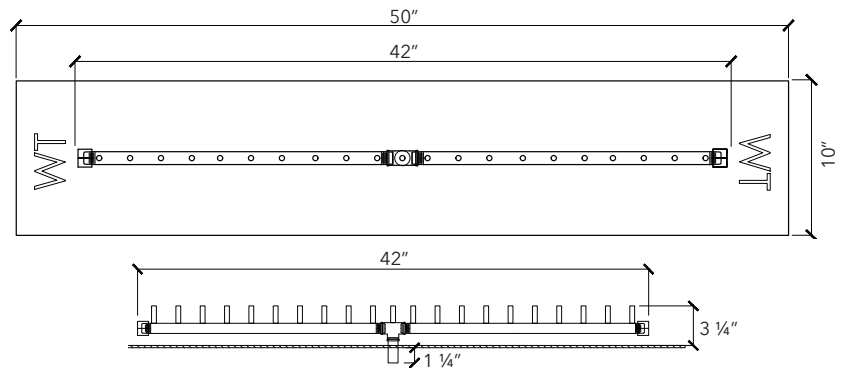
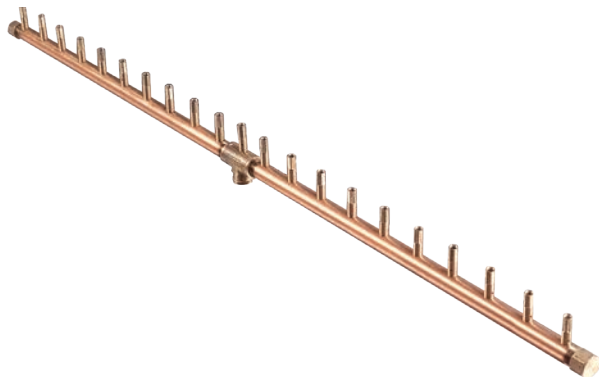

## LINEAR CFBL210

For 50" x 10" opening or larger

SKU (NG OR LP)	DESCRIPTION	SHIP WEIGHT	SHIP DIMENSIONS
CFBL210NG   CFBL210LP	210K BTU Linear Brass Burner	7 lbs	49" x 5" x 5"
Recommended parts: Plate: ALPL5010 • 3/4" Flex Line Kit • Optional 6x Support Collars			
CFBL210NGALPL5010 CFBL210LPALPL5010	with 50" x 10" Rectangular Plate	23 lbs	61" x 9" x 9"
CFBL210NGALPL5010FK1 CFBL210LPALPL5010FK1	with 50" x 10" Plate + 3/4" Flex Line Kit	26 lbs	61" x 9" x 9"
Compatible Ignition Systems: Push Button, 24 Volt Spark Ignition, 24 Volt Hot Surface Ignition (SC)			

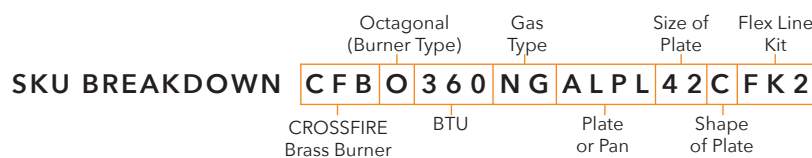

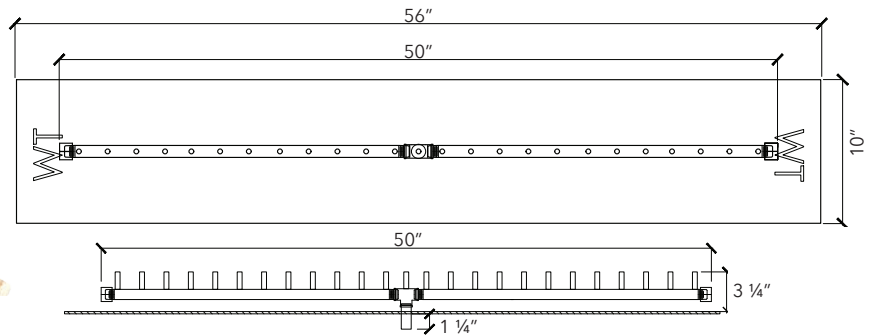
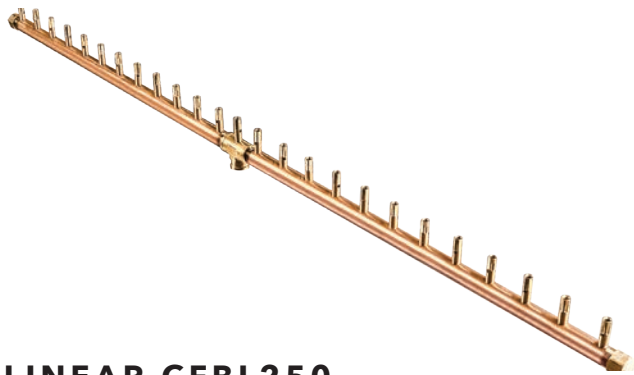

## LINEAR CFBL250

For 56" x 10" opening or larger

SKU (NG OR LP)

DESCRIPTION

SHIP WEIGHT

SHIP DIMENSIONS

CFBL250NG   CFBL250LP	250K BTU Linear Brass Burner	7 lbs	61" x 5" x 5"
Recommended parts: Plate: ALPL5610 • 3/4" Dual Flex Line Kit • Optional 7x Support Collars			
CFBL250NGALPL5610 CFBL250LPALPL5610	with 56" x 10" Rectangular Plate	25 lbs	61" x 9" x 9"
CFBL250NGALPL5610FK2 CFBL250LPALPL5610FK2	with 56" x 10" Plate + 3/4" Dual Flex Line Kit	32 lbs	61" x 9" x 9"
Compatible Ignition Systems: Push Button, 24 Volt Spark Ignition, 24 Volt Hot Surface Ignition (SC)			

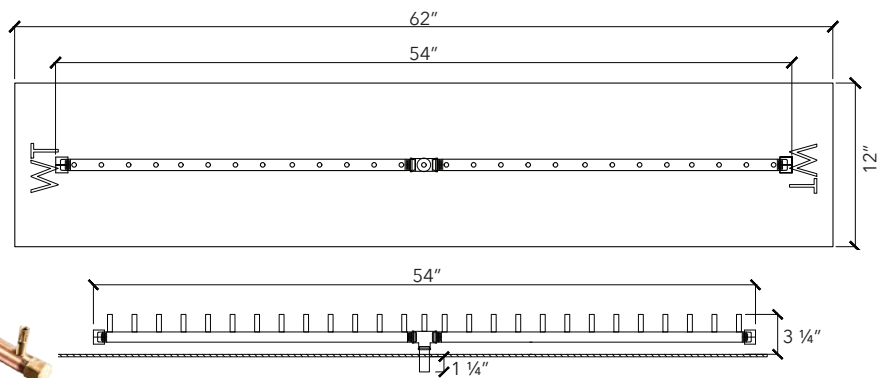
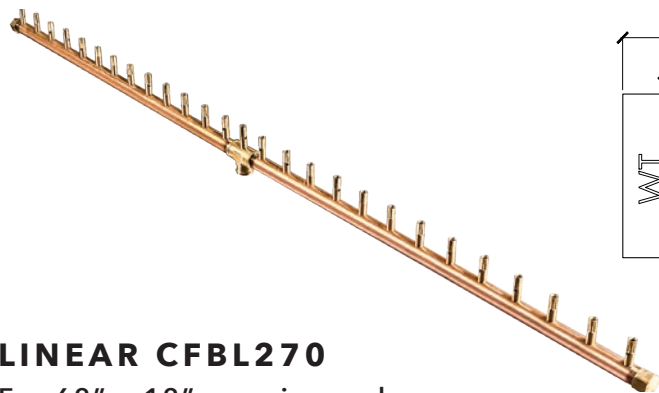

## LINEAR CFBL270

For 62" x 12" opening or larger

SKU (NG OR LP)

DESCRIPTION

SHIP WEIGHT

SHIP DIMENSIONS

CFBL270NG   CFBL270LP	270K BTU Linear Brass Burner	8 lbs	61" x 5" x 5"
Recommended parts: Plate: ALPL6212 • 3/4" Dual Flex Line Kit • Optional 8x Support Collars			
CFBL270NGALPL6212 CFBL270LPALPL6212	with 62" x 12" Rectangular Plate		SHIPS FREIGHT
CFBL270NGALPL6212FK2 CFBL270LPALPL6212FK2	with 62" x 12" Plate + 3/4" Dual Flex Line Kit		SHIPS FREIGHT
Compatible Ignition Systems: Push Button, 24 Volt Spark Ignition, 24 Volt Hot Surface Ignition (SC)			

**PLATE AND PAN OPTIONS ON PAGE 44**



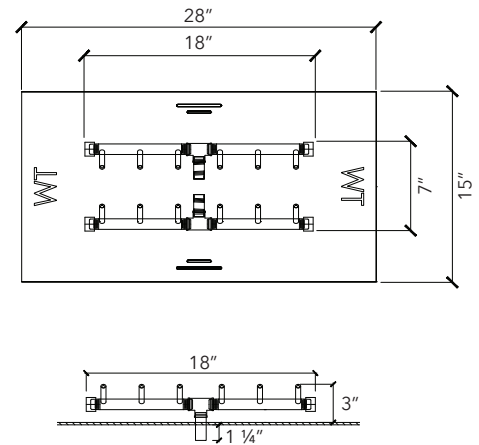

## H-STYLE CFBH120

For 28" x 15" opening or larger

SKU (NG OR LP)	DESCRIPTION	SHIP WEIGHT	SHIP DIMENSIONS
CFBH120NG   CFBH120LP	120K BTU H-Style Brass Burner	7 lbs	19" x 15" x 5"
Recommended parts: Plate: ALPL2815 • 3/4" Flex Line Kit • Optional 4x Support Collars			
CFBH120NGALPL2815 CFBH120LPALPL2815	with 28" x 15" Rectangular Plate	16 lbs	29" x 29" x 7"
CFBH120NGALPL2815FK1 CFBH120LPALPL2815FK1	with 28" x 15" Plate + 3/4" Flex Line Kit	19 lbs	29" x 29" x 7"
Compatible Ignition Systems: Push Button, 3 Volt, 24 Volt Spark Ignition, 24 Volt Hot Surface Ignition (SC)			

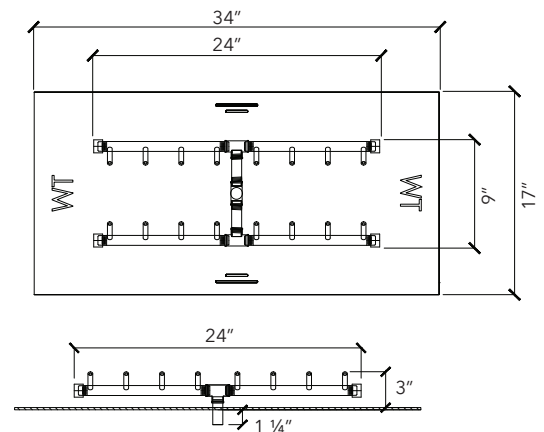

## H-STYLE CFBH160

For 34" x 17" opening or larger

SKU (NG OR LP)	DESCRIPTION	SHIP WEIGHT	SHIP DIMENSIONS
CFBH160NG   CFBH160LP	160K BTU H-Style Brass Burner	8 lbs	25" x 9" x 7"
Recommended parts: Plate: ALPL3417 • 3/4" Flex Line Kit • Optional 5x Support Collars			
CFBH160NGALPL3417 CFBH160LPALPL3417	with 34" x 17" Rectangular Plate	17 lbs	37" x 37" x 9"
CFBH160NGALPL3417FK1 CFBH160LPALPL3417FK1	with 34" x 17" Plate + 3/4" Flex Line Kit	20 lbs	37" x 37" x 9"
Compatible Ignition Systems: Push Button, 24 Volt Spark Ignition, 24 Volt Hot Surface Ignition (SC)			

**SKU BREAKDOWN**

CF	B	O	3	6	0	NG	AL	PL	4	2	C	FK	2
CROSSFIRE Brass Burner			BTU			Gas Type	Plate or Pan	Shape of Plate	Size of Plate		Flex Line Kit		

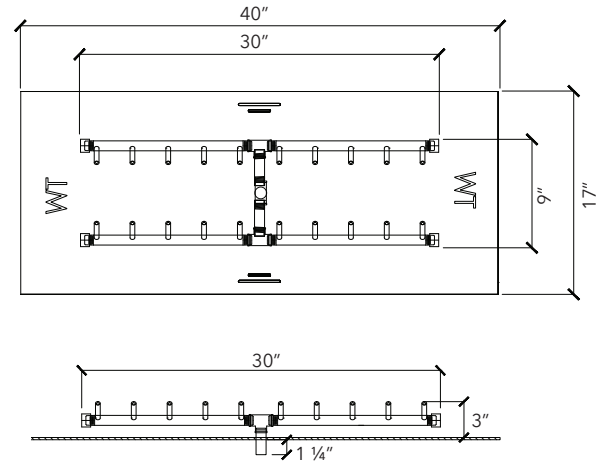

## H-STYLE CFBH200

For 40" x 17" opening or larger

SKU (NG OR LP)	DESCRIPTION	SHIP WEIGHT	SHIP DIMENSIONS
CFBH200NG   CFBH200LP	200K BTU H-Style Brass Burner	9 lbs	37" x 13" x 13"
Recommended parts: Plate: ALPL4017 • 3/4" Flex Line Kit • Optional 6x Support Collars			
CFBH200NGALPL4017 CFBH200LPALPL4017	with 40" x 17" Rectangular Plate	SHIPS FREIGHT	
CFBH200NGALPL4017FK1 CFBH200LPALPL4017FK1	with 40" x 17" Plate + 3/4" Flex Line Kit	SHIPS FREIGHT	
Compatible Ignition Systems: Push Button, 24 Volt Spark Ignition, 24 Volt Hot Surface Ignition (SC)			

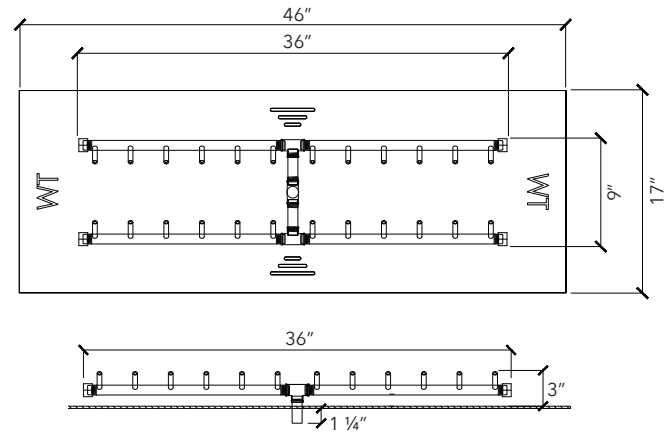

## H-STYLE CFBH240

For 46" x 17" opening or larger

SKU (NG OR LP)	DESCRIPTION	SHIP WEIGHT	SHIP DIMENSIONS
CFBH240NG   CFBH240LP	240K BTU H-Style Brass Burner	10 lbs	37" x 13" x 13"
Recommended parts: Plate: ALPL4617 • 3/4" Flex Line Kit • Optional 7x Support Collars			
CFBH240NGALPL4617 CFBH240LPALPL4617	with 46" x 17" Rectangular Plate	SHIPS FREIGHT	
CFBH240NGALPL4617FK1 CFBH240LPALPL4617FK1	with 46" x 17" Plate + 3/4" Flex Line Kit	SHIPS FREIGHT	
Compatible Ignition Systems: Push Button, 24 Volt Spark Ignition, 24 Volt Hot Surface Ignition (SC)			

**LIGHT IT UP! IGNITION SYSTEMS START ON PAGE 61**

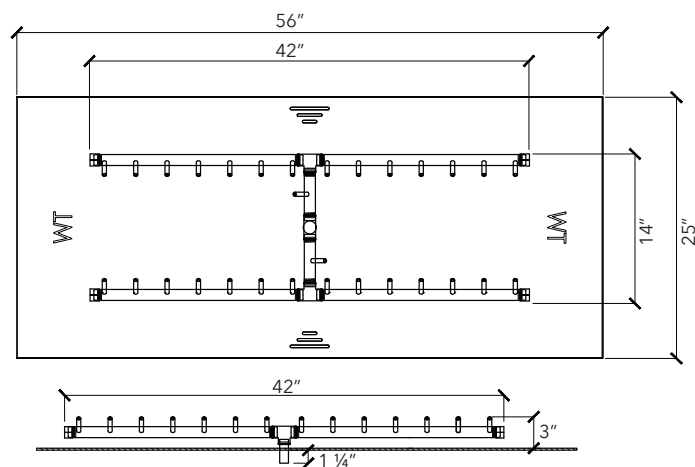

## H-STYLE CFBH300

For 56" x 25" opening or larger

SKU (NG OR LP)	DESCRIPTION	SHIP WEIGHT	SHIP DIMENSIONS
CFBH300NG   CFBH300LP	300K BTU H-Style Brass Burner	20 lbs	49" x 17" x 17"
Recommended parts: Plate: ALPL5625 • 3/4" Dual Flex Line Kit • Optional 9x Support Collars			
CFBH300NGALPL5625 CFBH300LPALPL5625	with 56" x 25" Rectangular Plate	SHIPS FREIGHT	
CFBH300NGALPL5625FK2 CFBH300LPALPL5625FK2	with 56" x 25" Plate + 3/4" Dual Flex Line Kit	SHIPS FREIGHT	
Compatible Ignition Systems: Push Button, 24 Volt Spark Ignition, 24 Volt Hot Surface Ignition (HC)			

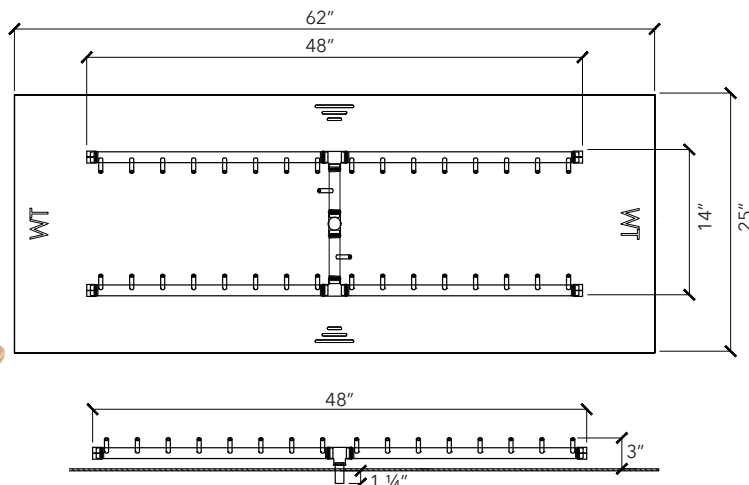

## H-STYLE CFBH340

For 62" x 25" opening or larger

SKU (NG OR LP)	DESCRIPTION	SHIP WEIGHT	SHIP DIMENSIONS
CFBH340NG   CFBH340LP	340K BTU H-Style Brass Burner	14 lbs	49" x 17" x 17"
Recommended parts: Plate: ALPL6225 • 3/4" Dual Flex Line Kit • Optional 9x Support Collars			
CFBH340NGALPL6225 CFBH340LPALPL6225	with 62" x 25" Rectangular Plate	SHIPS FREIGHT	
CFBH340NGALPL6225FK2 CFBH340LPALPL6225FK2	with 62" x 25" Plate + 3/4" Dual Flex Line Kit	SHIPS FREIGHT	
Compatible Ignition Systems: 24 Volt Spark Ignition, 24 Volt Hot Surface Ignition (HC)			

**SKU BREAKDOWN**

CF	B	O	3	6	0	NG	AL	PL	4	2	C	FK	2
CROSSFIRE Brass Burner			BTU			Gas Type	Plate or Pan		Size of Plate		Flex Line Kit		

# PLATES, PANS & COVERS

Cut from aluminum using state-of-the-art water jet technology, Warming Trends plates and pans are corrosion resistant and include drainage vents.

## TECH TIP

Plate should be sized slightly smaller than the measurement of the opening.  
This allows easier installation and removal for service.

## CIRCULAR PLATES and PANS

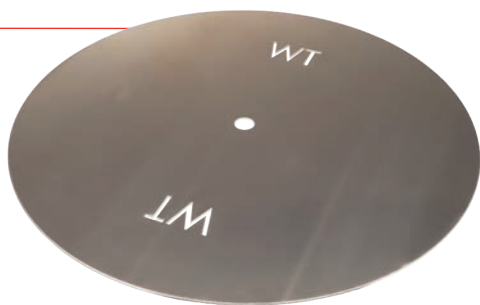

### Plates

SKU	DESCRIPTION	SHIP WEIGHT + DIMS	
ALPL18C	18" Circular	4 lbs	19" x 19" x 7"
ALPL24C	24" Circular	5 lbs	25" x 25" x 7"
ALPL30C	30" Circular	8 lbs	31" x 31" x 7"
ALPL36C	36" Circular	12 lbs	37" x 37" x 9"
ALPL42C	42" Circular	SHIPS FREIGHT	
ALPL48C	48" Circular	SHIPS FREIGHT	
ALPL60C	60" Circular	SHIPS FREIGHT	
ALPL12-17C	12" - 17" Circular	4 lbs	19" x 19" x 7"
ALPL19-23C	19" - 23" Circular	5 lbs	25" x 25" x 7"
ALPL25-29C	25" - 29" Circular	8 lbs	31" x 31" x 7"
ALPL31-35C	31" - 35" Circular	12 lbs	37" x 37" x 9"
ALPL37-41C	37" - 41" Circular	SHIPS FREIGHT	
ALPL43-47C	43" - 47" Circular	SHIPS FREIGHT	
ALPL49-59C	49" - 59" Circular	SHIPS FREIGHT	
ALPL61-66C	61" - 66" Circular	SHIPS FREIGHT	
ALPL67-72C	67" - 72" Circular	SHIPS FREIGHT	
ALPL73-80C	73" - 80" Circular	SHIPS FREIGHT	
ALPLCUST	Aluminum plate customized to any shape or size	Call for Quote	

### Pans (Pans include 2" welded sidewall)

SKU	DESCRIPTION	SHIP WEIGHT + DIMS	
ALPAN18C	18" Circular	7 lbs	19" x 19" x 7"
ALPAN24C	24" Circular	9 lbs	25" x 25" x 7"
ALPAN30C	30" Circular	12 lbs	31" x 31" x 7"
ALPAN36C	36" Circular	17 lbs	37" x 37" x 9"
ALPAN42C	42" Circular	SHIPS FREIGHT	
ALPAN48C	48" Circular	SHIPS FREIGHT	
ALPAN60C	60" Circular	SHIPS FREIGHT	
ALPAN12-17C	12" - 17" Circular	6 lbs	19" x 19" x 7"
ALPAN19-23C	19" - 23" Circular	9 lbs	25" x 25" x 7"
ALPAN25-29C	25" - 29" Circular	12 lbs	31" x 31" x 7"
ALPAN31-35C	31" - 35" Circular	16 lbs	37" x 37" x 9"
ALPAN37-41C	37" - 41" Circular	SHIPS FREIGHT	
ALPAN43-47C	43" - 47" Circular	SHIPS FREIGHT	
ALPAN49-59C	49" - 59" Circular	SHIPS FREIGHT	
ALPANCUST	Aluminum pan customized to any shape or size	Call for Quote	





PLATES,  
PANS,  
& COVERS

## SQUARE PLATES and PANS

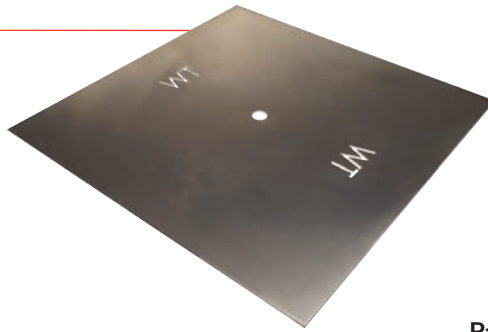

### Plates

SKU	DESCRIPTION	SHIP WEIGHT + DIMS	
ALPL18S	18" Square	4 lbs	21" x 21" x 7"
ALPL24S	24" Square	7 lbs	27" x 27" x 7"
ALPL30S	30" Square	10 lbs	33" x 33" x 9"
ALPL36S	36" Square	15 lbs	39" x 39" x 7"
ALPL42S	42" Square	SHIPS FREIGHT	
ALPL48S	48" Square	SHIPS FREIGHT	
ALPL60S	60" Square	SHIPS FREIGHT	
ALPL12-17S	12" - 17" Square	4 lbs	19" x 19" x 7"
ALPL19-23S	19" - 23" Square	7 lbs	25" x 25" x 7"
ALPL25-29S	25" - 29" Square	10 lbs	31" x 31" x 7"
ALPL31-35S	31" - 35" Square	15 lbs	37" x 37" x 9"
ALPL37-41S	37" - 41" Square	SHIPS FREIGHT	
ALPL43-47S	43" - 47" Square	SHIPS FREIGHT	
ALPL49-59S	49" - 59" Square	SHIPS FREIGHT	
ALPL61-66S	61" - 66" Square	SHIPS FREIGHT	
ALPL67-72S	67" - 72" Square	SHIPS FREIGHT	
ALPL73-80S	73" - 80" Square	SHIPS FREIGHT	
ALPLCUST	Aluminum plate customized to any shape or size	Call for Quote	

### Pans (Pans include 2" welded sidewall)

SKU	DESCRIPTION	SHIP WEIGHT + DIMS	
ALPAN18S	18" Square	8 lbs	21" x 21" x 7"
ALPAN24S	24" Square	11 lbs	27" x 27" x 7"
ALPAN30S	30" Square	15 lbs	33" x 33" x 9"
ALPAN36S	36" Square	20 lbs	39" x 39" x 7"
ALPAN42S	42" Square	SHIPS FREIGHT	
ALPAN48S	48" Square	SHIPS FREIGHT	
ALPAN60S	60" Square	SHIPS FREIGHT	
ALPAN12-17S	12" - 17" Square	7 lbs	19" x 19" x 7"
ALPAN19-23S	19" - 23" Square	10 lbs	25" x 25" x 7"
ALPAN25-29S	25" - 29" Square	14 lbs	31" x 31" x 7"
ALPAN31-35S	31" - 35" Square	19 lbs	37" x 37" x 9"
ALPAN37-41S	37" - 41" Square	SHIPS FREIGHT	
ALPAN43-47S	43" - 47" Square	SHIPS FREIGHT	
ALPAN49-59S	49" - 59" Square	SHIPS FREIGHT	
ALPANCUST	Aluminum pan customized to any shape or size	Call for Quote	

## RECTANGULAR PLATES

SKU	DESCRIPTION	
	Length	Width
PLR2312	18" - 23.9"	6" - 12.9"
PLR2912	24" - 29.9"	6" - 12.9"
PLR3512	30" - 35.9"	6" - 12.9"
PLR4112	36" - 41.9"	6" - 12.9"
PLR4712	42" - 47.9"	6" - 12.9"
PLR5312	48" - 53.9"	6" - 12.9"
PLR6112	54" - 61.9"	6" - 12.9"
PLR6712	62" - 67.9"	6" - 12.9"
PLR7312	68" - 73.9"	6" - 12.9"
PLR7912	74" - 79.9"	6" - 12.9"
PLR8512	80" - 85.9"	6" - 12.9"
PLR9112	86" - 91.9"	6" - 12.9"
PLR9712	92" - 97.9"	6" - 12.9"
PLR10312	98" - 103.9"	6" - 12.9"
PLR10912	104" - 109.9"	6" - 12.9"
PLR11512	110" - 115.9"	6" - 12.9"
PLR12012	116" - 120"	6" - 12.9"
PLR2317	18" - 23.9"	13" - 17.9"
PLR2917	24" - 29.9"	13" - 17.9"
PLR3517	30" - 35.9"	13" - 17.9"
PLR4117	36" - 41.9"	13" - 17.9"
PLR4717	42" - 47.9"	13" - 17.9"
PLR5317	48" - 53.9"	13" - 17.9"
PLR6117	54" - 61.9"	13" - 17.9"
PLR6717	62" - 67.9"	13" - 17.9"
PLR7317	68" - 73.9"	13" - 17.9"
PLR7917	74" - 79.9"	13" - 17.9"
PLR8517	80" - 85.9"	13" - 17.9"
PLR9117	86" - 91.9"	13" - 17.9"
PLR9717	92" - 97.9"	13" - 17.9"
PLR10317	98" - 103.9"	13" - 17.9"
PLR10917	104" - 109.9"	13" - 17.9"
PLR11517	110" - 115.9"	13" - 17.9"
PLR12017	116" - 120"	13" - 17.9"

SKU	DESCRIPTION	
	Length	Width
PLR2923	24" - 29.9"	18" - 23.9"
PLR3523	30" - 35.9"	18" - 23.9"
PLR4123	36" - 41.9"	18" - 23.9"
PLR4723	42" - 47.9"	18" - 23.9"
PLR5323	48" - 53.9"	18" - 23.9"
PLR6123	54" - 61.9"	18" - 23.9"
PLR6723	62" - 67.9"	18" - 23.9"
PLR7323	68" - 73.9"	18" - 23.9"
PLR7923	74" - 79.9"	18" - 23.9"
PLR8523	80" - 85.9"	18" - 23.9"
PLR9123	86" - 91.9"	18" - 23.9"
PLR9723	92" - 97.9"	18" - 23.9"
PLR10323	98" - 103.9"	18" - 23.9"
PLR10923	104" - 109.9"	18" - 23.9"
PLR11523	110" - 115.9"	18" - 23.9"
PLR12023	116" - 120"	18" - 23.9"
PLR4130	36" - 41.9"	24" - 30"
PLR4730	42" - 47.9"	24" - 30"
PLR5330	48" - 53.9"	24" - 30"
PLR6130	54" - 61.9"	24" - 30"
PLR6730	62" - 67.9"	24" - 30"
PLR7330	68" - 73.9"	24" - 30"
PLR7930	74" - 79.9"	24" - 30"
PLR8530	80" - 85.9"	24" - 30"
PLR9130	86" - 91.9"	24" - 30"
PLR9730	92" - 97.9"	24" - 30"
PLR10330	98" - 103.9"	24" - 30"
PLR10930	104" - 109.9"	24" - 30"
PLR11530	110" - 115.9"	24" - 30"
PLR12030	116" - 120"	24" - 30"

Ship Weight and Dimensions vary. Please contact for quote. Rectangular pans available.



## CIRCULAR AND SQUARE COVERS

### Circular

SKU	DESCRIPTION	SHIP WEIGHT + DIMS	
CCR1419	14" - 19.9" Circular + 1 handle. For 12" - 17.9" opening	Ship Weight and Dimensions vary	
FPC20C	20" Circular + 1 handle. For 18" opening	9 lbs	21" x 21" x 7"
CCR2025	20.1" - 25.9" Circular + 1 handle. For 18.1" - 23.9" opening	Ship Weight and Dimensions vary	
FPC26C	26" Circular + 1 handle. For 24" opening	13 lbs	27" x 27" x 7"
CCR2631	26.1" - 31.9" Circular + 1 handle. For 24.1" - 29.9" opening	Ship Weight and Dimensions vary	
FPC32C	32" Circular + 1 handle. For 30" opening	19 lbs	33" x 33" x 9"
CCR3227	32.1" - 37.9" Circular + 1 handle. For 30.1" - 35.9" opening	Ship Weight and Dimensions vary	
FPC38C	38" Circular + 2 handles. For 36" opening	23 lbs	39" x 39" x 7"
CCR3843	38.1" - 43.9" Circular + 2 handles. For 36.1" - 41.9" opening	SHIPS FREIGHT	
FPC44C	44" Circular + 2 handles. For 42" opening	SHIPS FREIGHT	
CCR4449	44.1" - 49.9" Circular + 2 handles. For 42.1" - 47.9" opening	SHIPS FREIGHT	
FPC50C	50" Circular + 2 handles. For 48" opening	SHIPS FREIGHT	
CCR5055	50.1" - 55.9" Circular + 2 handles. For 48.1" - 53.9" opening	SHIPS FREIGHT	
CCR5661	56" - 61.9" Circular + 2 handles. For 54" - 59.9" opening	SHIPS FREIGHT	
FPC62C	62" Circular + 2 handles. For 60" opening	SHIPS FREIGHT	
CCR6267	62.1" - 67.9" Circular + 2 handles. For 60.1" - 65.9" opening	SHIPS FREIGHT	
CCR6872	68" - 72" Circular + 2 handles. For 66" - 70" opening	SHIPS FREIGHT	



### Square

SKU	DESCRIPTION	SHIP WEIGHT + DIMS	
CSR1419	14" - 19.9" Square + 1 handle. For 12" - 17.9" opening	Ship Weight and Dimensions vary	
FPC20S	20" Square + 1 handle. For 18" opening	10 lbs	23" x 23" x 7"
CSR2025	20.1" - 25.9" Square + 1 handle. For 18.1" - 23.9" opening	Ship Weight and Dimensions vary	
FPC26S	26" Square + 1 handle. For 24" opening	16 lbs	29" x 29" x 7"
CSR2631	26.1" - 31.9" Square + 1 handle. For 24.1" - 29.9" opening	Ship Weight and Dimensions vary	
FPC32S	32" Square + 1 handle. For 30" opening	23 lbs	37" x 37" x 9"
CSR3237	32.1" - 37.9" Square + 1 handle. For 30.1" - 35.9" opening	Ship Weight and Dimensions vary	
FPC38S	38" Square + 2 handles. For 36" opening	SHIPS FREIGHT	
CSR3843	38.1" - 43.9" Square + 2 handles. For 36.1" - 41.9" opening	SHIPS FREIGHT	
FPC44S	44" Square + 2 handles. For 42" opening	SHIPS FREIGHT	
CSR4449	44.1" - 49.9" Square + 2 handles. For 42.1" - 47.9" opening	SHIPS FREIGHT	
FPC50S	50" Square + 2 handles. For 48" opening	SHIPS FREIGHT	
CSR5055	50.1" - 55.9" Square + 2 handles. For 48.1" - 53.9" opening	SHIPS FREIGHT	
CSR5661	56" - 61.9" Square + 2 handles. For 54" - 59.9" opening	SHIPS FREIGHT	
FPC62S	62" Square + 2 handles. For 60" opening	SHIPS FREIGHT	
CSR6267	62.1" - 67.9" Square + 2 handles. For 60.1" - 65.9" opening	SHIPS FREIGHT	
CSR6872	68" - 72" Square + 2 handles. For 66" - 70" opening	SHIPS FREIGHT	



## RECTANGULAR COVERS

### TECH TIP

Covers should be sized at least 2" larger than the measurement of the opening.  
This allows easier installation and removal for service.

SKU	DESCRIPTION		
	Length	Width	
CRR2312	18" - 23.9"	6" - 12.9"	18" - 23.9" x 6" - 12.9" Rectangular + 1 handle.
CRR2912	24" - 29.9"	6" - 12.9"	24" - 29.9" x 6" - 12.9" Rectangular + 1 handle.
CRR3512	30" - 35.9"	6" - 12.9"	30" - 35.9" x 6" - 12.9" Rectangular + 1 handle.
CRR4112	36" - 41.9"	6" - 12.9"	36" - 41.9" x 6" - 12.9" Rectangular + 2 handles.
CRR4712	42" - 47.9"	6" - 12.9"	42" - 47.9" x 6" - 12.9" Rectangular + 2 handles.
CRR5312	48" - 53.9"	6" - 12.9"	48" - 53.9" x 6" - 12.9" Rectangular + 2 handles.
CRR6112	54" - 61.9"	6" - 12.9"	54" - 61.9" x 6" - 12.9" Rectangular + 2 handles.
CRR6712	62" - 67.9"	6" - 12.9"	62" - 67.9" x 6" - 12.9" Rectangular + 2 handles.
CRR7312	68" - 73.9"	6" - 12.9"	68" - 73.9" x 6" - 12.9" Rectangular + 2 handles.
CRR7912	74" - 79.9"	6" - 12.9"	74" - 79.9" x 6" - 12.9" Rectangular + 2 handles.
CRR8512	80" - 85.9"	6" - 12.9"	80" - 85.9" x 6" - 12.9" Rectangular + 2 handles.
CRR9112	86" - 91.9"	6" - 12.9"	86" - 91.9" x 6" - 12.9" Rectangular + 2 handles.
CRR9712	92" - 97.9"	6" - 12.9"	92" - 97.9" x 6" - 12.9" Rectangular + 2 handles.
CRR10312	98" - 103.9"	6" - 12.9"	98" - 103.9" x 6" - 12.9" Rectangular + 2 handles.
CRR10912	104" - 109.9"	6" - 12.9"	104" - 109.9" x 6" - 12.9" Rectangular + 2 handles.
CRR11512	110" - 115.9"	6" - 12.9"	110" - 115.9" x 6" - 12.9" Rectangular + 2 handles.
CRR12212	116" - 120"	6" - 12.9"	116" - 120" x 6" - 12.9" Rectangular + 2 handles.
CRR2317	18" - 23.9"	13" - 17.9"	18" - 23.9" x 13" - 17.9" Rectangular + 1 handle.
CRR2917	24" - 29.9"	13" - 17.9"	24" - 29.9" x 13" - 17.9" Rectangular + 1 handle.
CRR3517	30" - 35.9"	13" - 17.9"	30" - 35.9" x 13" - 17.9" Rectangular + 1 handle.
CRR4117	36" - 41.9"	13" - 17.9"	36" - 41.9" x 13" - 17.9" Rectangular + 2 handles.
CRR4717	42" - 47.9"	13" - 17.9"	42" - 47.9" x 13" - 17.9" Rectangular + 2 handles.
CRR5317	48" - 53.9"	13" - 17.9"	48" - 53.9" x 13" - 17.9" Rectangular + 2 handles.
CRR6117	54" - 61.9"	13" - 17.9"	54" - 61.9" x 13" - 17.9" Rectangular + 2 handles.
CRR6717	62" - 67.9"	13" - 17.9"	62" - 67.9" x 13" - 17.9" Rectangular + 2 handles.
CRR7317	68" - 73.9"	13" - 17.9"	68" - 73.9" x 13" - 17.9" Rectangular + 2 handles.
CRR7917	74" - 79.9"	13" - 17.9"	74" - 79.9" x 13" - 17.9" Rectangular + 2 handles.
CRR8517	80" - 85.9"	13" - 17.9"	80" - 85.9" x 13" - 17.9" Rectangular + 2 handles.
CRR9117	86" - 91.9"	13" - 17.9"	86" - 91.9" x 13" - 17.9" Rectangular + 2 handles.
CRR9717	92" - 97.9"	13" - 17.9"	92" - 97.9" x 13" - 17.9" Rectangular + 2 handles.
CRR10317	98" - 103.9"	13" - 17.9"	98" - 103.9" x 13" - 17.9" Rectangular + 2 handles.
CRR10917	104" - 109.9"	13" - 17.9"	104" - 109.9" x 13" - 17.9" Rectangular + 2 handles.
CRR11517	110" - 115.9"	13" - 17.9"	110" - 115.9" x 13" - 17.9" Rectangular + 2 handles.
CRR12017	116" - 120"	13" - 17.9"	116" - 120" x 13" - 17.9" Rectangular + 2 handles.

Ship Weight and Dimensions vary. Please contact for quote. Rectangular pans available.



## RECTANGULAR COVERS

SKU	DESCRIPTION		
	Length	Width	
CRR2923	24" - 29.9"	18" - 23.9"	24" - 29.9" x 18" - 23.9" Rectangular + 1 handle.
CRR3523	30" - 35.9"	18" - 23.9"	30" - 35.9" x 18" - 23.9" Rectangular + 1 handle.
CRR4123	36" - 41.9"	18" - 23.9"	36" - 41.9" x 18" - 23.9" Rectangular + 2 handles.
CRR4723	42" - 47.9"	18" - 23.9"	42" - 47.9" x 18" - 23.9" Rectangular + 2 handles.
CRR5323	48" - 53.9"	18" - 23.9"	48" - 53.9" x 18" - 23.9" Rectangular + 2 handles.
CRR6123	54" - 61.9"	18" - 23.9"	54" - 61.9" x 18" - 23.9" Rectangular + 2 handles.
CRR6723	62" - 67.9"	18" - 23.9"	62" - 67.9" x 18" - 23.9" Rectangular + 2 handles.
CRR7323	68" - 73.9"	18" - 23.9"	68" - 73.9" x 18" - 23.9" Rectangular + 2 handles.
CRR7923	74" - 79.9"	18" - 23.9"	74" - 79.9" x 18" - 23.9" Rectangular + 2 handles.
CRR8523	80" - 85.9"	18" - 23.9"	80" - 85.9" x 18" - 23.9" Rectangular + 2 handles.
CRR91123	86" - 91.9"	18" - 23.9"	86" - 91.9" x 18" - 23.9" Rectangular + 2 handles.
CRR9723	92" - 97.9"	18" - 23.9"	92" - 97.9" x 18" - 23.9" Rectangular + 2 handles.
CRR10323	98" - 103.9"	18" - 23.9"	98" - 103.9" x 18" - 23.9" Rectangular + 2 handles.
CRR10923	104" - 109.9"	18" - 23.9"	104" - 109.9" x 18" - 23.9" Rectangular + 2 handles.
CRR11523	110" - 115.9"	18" - 23.9"	110" - 115.9" x 18" - 23.9" Rectangular + 2 handles.
CRR12223	116" - 122"	18" - 23.9"	116" - 122" x 18" - 23.9" Rectangular + 2 handles.
CRR4130	36" - 41.9"	24" - 30"	36" - 41.9" x 24" - 30" Rectangular + 2 handles.
CRR4730	42" - 47.9"	24" - 30"	36" - 41.9" x 24" - 30" Rectangular + 2 handles.
CRR5330	48" - 53.9"	24" - 30"	48" - 53.9" x 24" - 30" Rectangular + 2 handles.
CRR6130	54" - 61.9"	24" - 30"	54" - 61.9" x 24" - 30" Rectangular + 2 handles.
CRR6730	62" - 67.9"	24" - 30"	62" - 67.9" x 24" - 30" Rectangular + 2 handles.
CRR7330	68" - 73.9"	24" - 30"	68" - 73.9" x 24" - 30" Rectangular + 2 handles.
CRR7930	74" - 79.9"	24" - 30"	74" - 79.9" x 24" - 30" Rectangular + 2 handles.
CRR8530	80" - 85.9"	24" - 30"	80" - 85.9" x 24" - 30" Rectangular + 2 handles.
CRR9130	86" - 91.9"	24" - 30"	86" - 91.9" x 24" - 30" Rectangular + 2 handles.
CRR9730	92" - 97.9"	24" - 30"	92" - 97.9" x 24" - 30" Rectangular + 2 handles.
CRR10330	98" - 103.9"	24" - 30"	98" - 103.9" x 24" - 30" Rectangular + 2 handles.
CRR10930	104" - 109.9"	24" - 30"	104" - 109.9" x 24" - 30" Rectangular + 2 handles.
CRR11530	110" - 115.9"	24" - 30"	110" - 115.9" x 24" - 30" Rectangular + 2 handles.
CRR12230	116" - 122"	24" - 30"	116" - 122" x 24" - 30" Rectangular + 2 handles.

Ship Weight and Dimensions vary. Please contact for quote. Rectangular pans available.



## READY-TO-FINISH KITS

---

Aluminum frames covered with concrete board, ready to be easily and quickly completed with your choice of stone or veneer.

Simply place on site, connect to the gas supply, add stone or other veneer and your fire feature is complete.

Need a different size or shape? We're happy to help. Call our Flame Consultants at 877 556 5255

## RECTANGULAR LINEAR READY-TO-FINISH KITS

### TECH TIP

Ready-to-Finish Kits come with a Fire Pit Vent Kit (FPVK) but they do not come pre-installed as placement and installation depends on veneer. Vents are to be installed by contractor on site.



FR6036 shown

READY-TO-FINISH KITS

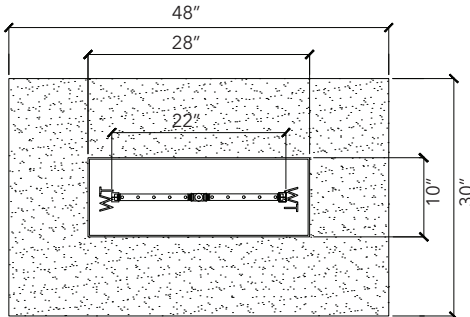

### FR4830NG | FR4830LP

48" L x 30" W x 18" H Aluminum Frame with Concrete Board Attached  
 CFBL110 22" Linear Brass Burner  
 28" x 10" Aluminum Pan with 2" Sidewalls  
 Fire Pit Vent Kit  
 3/4" Flex Line Kit  
 Key Valve Extension  
 Ignition systems available: Push Button, 3 Volt, 24 Volt Spark Ignition, 24 Volt Hot Surface Ignition (SC)

SHIPS FREIGHT

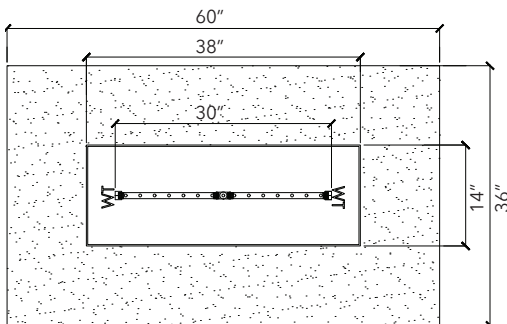

### FR6036NG | FR6036LP

60" L x 36" W x 18" H Aluminum Frame with Concrete Board Attached  
 CFBL150 30" Linear Brass Burner  
 38" x 14" Aluminum Pan with 2" Sidewalls  
 Fire Pit Vent Kit  
 3/4" Flex Line Kit  
 Key Valve Extension  
 Ignition systems available: Push Button, 24 Volt Spark Ignition, 24 Volt Hot Surface Ignition (SC)

SHIPS FREIGHT

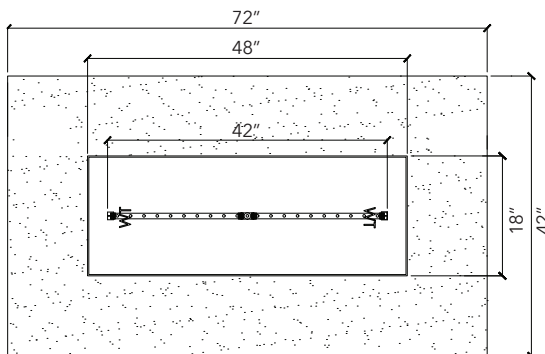

### FR7242NG | FR7242LP

72" L x 42" W x 18" H Aluminum Frame with Concrete Board Attached  
 CFBL210 42" Linear Brass Burner  
 48" x 18" Aluminum Pan with 2" Sidewalls  
 Fire Pit Vent Kit  
 3/4" Flex Line Kit  
 Key Valve Extension  
 Ignition systems available: Push Button, 24 Volt Spark Ignition, 24 Volt Hot Surface Ignition (SC)

SHIPS FREIGHT

## FIRESTORM® STEEL LOG

Handcrafted, one-of-a-kind steel gas log features an integrated linear burner and is sized perfectly for the FR6036 Rectangular Ready-to-Finish Kit.

Custom designs and sizes available.

See page 68 for more information or call us at 877 556 5255





## RECTANGULAR TREE- STYLE READY-TO-FINISH KITS

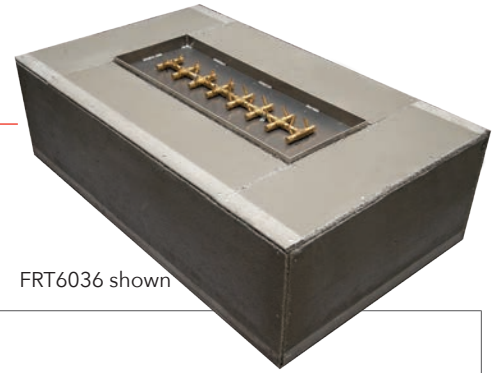

FRT6036 shown

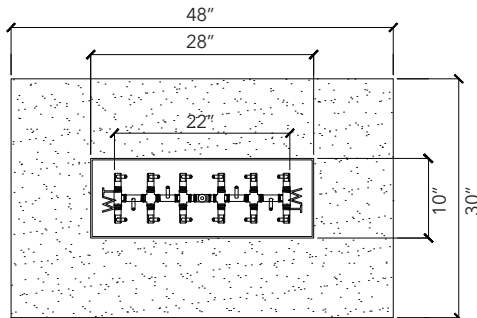

### FRT4830NG | FRT4830LP

48" L x 30" W x 18" H Aluminum Frame with Concrete Board Attached  
 CFBT170 Tree-Style Brass Burner  
 28" x 10" Aluminum Pan with 2" Sidewalls  
 Fire Pit Vent Kit  
 3/4" Flex Line Kit  
 Key Valve Extension  
 Ignition systems available: Push Button, 24 Volt Spark Ignition, 24 Volt Hot Surface Ignition (SC)

SHIPS FREIGHT

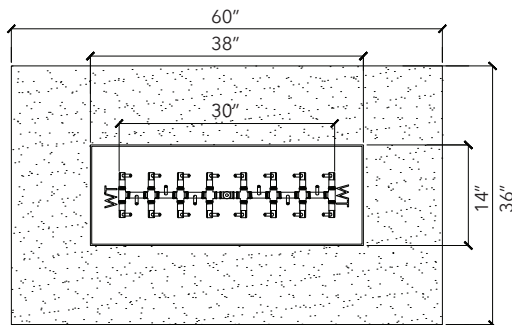

### FRT6036NG | FRT6036LP

60" L x 36" W x 18" H Aluminum Frame with Concrete Board Attached  
 CFBT230 Tree-Style Brass Burner  
 38" x 14" Aluminum Pan with 2" Sidewalls  
 Fire Pit Vent Kit  
 3/4" Flex Line Kit  
 Key Valve Extension  
 Ignition systems available: Push Button, 24 Volt Spark Ignition, 24 Volt Hot Surface Ignition (SC)

SHIPS FREIGHT

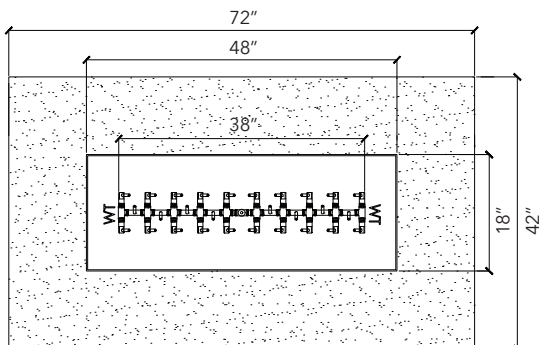

### FRT7242NG | FRT7242LP

72" L x 42" W x 18" H Aluminum Frame with Concrete Board Attached  
 CFBT290 Tree-Style Brass Burner  
 48" x 18" Aluminum Pan with 2" Sidewalls  
 Fire Pit Vent Kit  
 3/4" Dual Flex Line Kit  
 Key Valve Extension  
 Ignition systems available: Push Button, 24 Volt Spark Ignition, 24 Volt Hot Surface Ignition (SC)

SHIPS FREIGHT



## CUSTOM READY-TO-FINISH KITS

Your design is custom. Your fire feature should be, too.

Every day Warming Trends designs and manufactures truly custom fire feature solutions.

Let us create a custom feature for you.  
 We'd love to help. **877 556 5255**



# OCTAGONAL READY-TO-FINISH KITS

## TECH TIP

Ready-to-Finish Kits come with a Fire Pit Vent Kit (FPVK) but they do not come pre-installed as placement and installation depends on veneer. Vents are to be installed by contractor on site.



FO54 shown

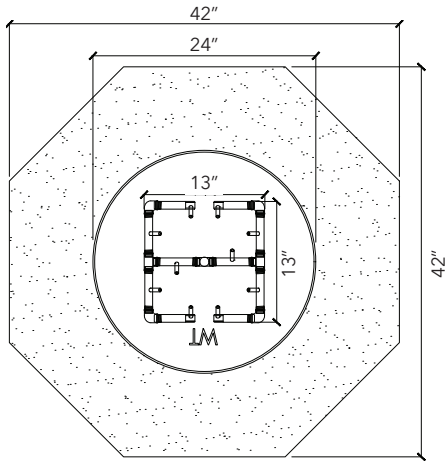

### FO42NG | FO42LP

42" W x 18" H Aluminum Frame with Concrete Board Attached  
 CFB120 Original Brass Burner  
 24" Aluminum Pan with 2" Sidewalls  
 Fire Pit Vent Kit  
 3/4" Flex Line Kit  
 Key Valve Extension  
 Ignition systems available: Push Button, 3 Volt, 24 Volt Spark Ignition,  
 24 Volt Hot Surface Ignition (SC)

SHIPS FREIGHT

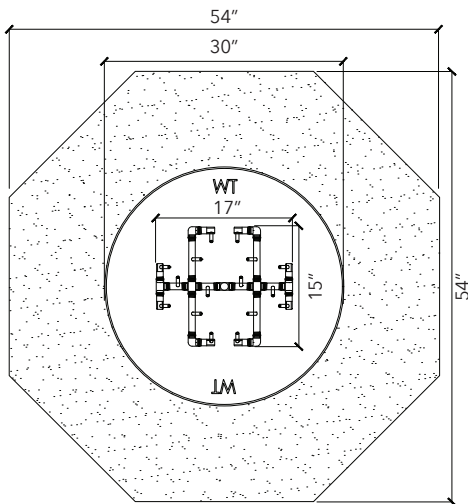

### FO54NG | FO54LP

54" W x 18" H Aluminum Frame with Concrete Board Attached  
 CFB180 Original Brass Burner  
 30" Aluminum Pan with 2" Sidewalls  
 Fire Pit Vent Kit  
 3/4" Flex Line Kit  
 Key Valve Extension  
 Ignition systems available: Push Button, 24 Volt Spark Ignition, 24 Volt Hot  
 Surface Ignition (SC)

SHIPS FREIGHT

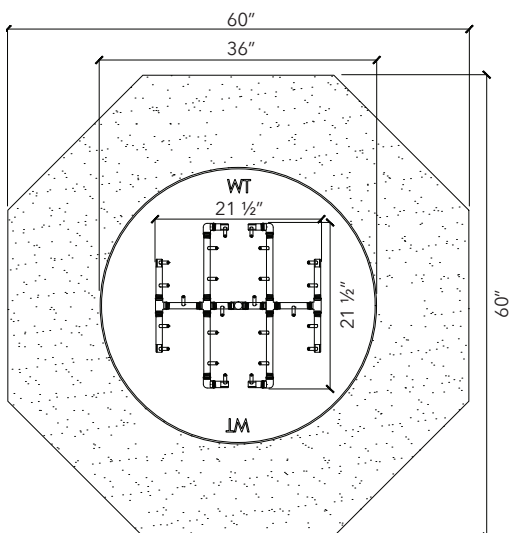

### FO60NG | FO60LP

60" W x 18" H Aluminum Frame with Concrete Board Attached  
 CFB290 Original Brass Burner  
 36" Aluminum Pan with 2" Sidewalls  
 Fire Pit Vent Kit  
 3/4" Dual Flex Line Kit  
 Key Valve Extension  
 Ignition systems available: Push Button, 24 Volt Spark Ignition, 24 Volt Hot  
 Surface Ignition (SC)

SHIPS FREIGHT

# CIRCULAR READY-TO-FINISH KITS

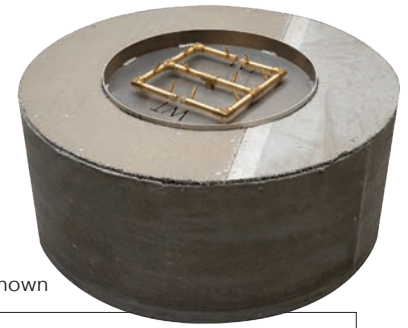

FC42 shown

## TECH TIP

Ready-to-Finish Kits come with a Fire Pit Vent Kit (FPVK) but they do not come pre-installed as placement and installation depends on veneer. Vents are to be installed by contractor on site.

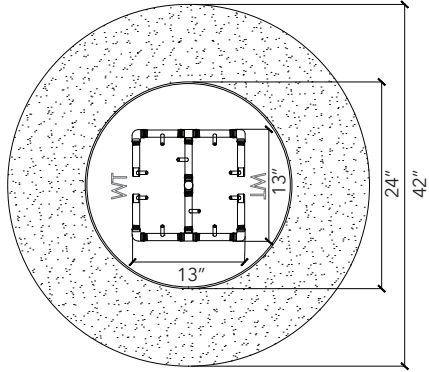

### FC42NG | FC42LP

42" W x 18" H Aluminum Frame with Concrete Board Attached  
 CFB120 Original Brass Burner  
 24" Aluminum Pan with 2" Sidewalls  
 Fire Pit Vent Kit  
 3/4" Flex Line Kit  
 Key Valve Extension  
 Ignition systems available: Push Button, 3 Volt, 24 Volt Spark Ignition,  
 24 Volt Hot Surface Ignition (SC)

SHIPS FREIGHT

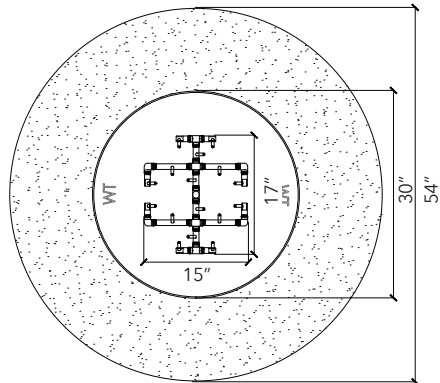

### FC54NG | FC54LP

54" W x 18" H Aluminum Frame with Concrete Board Attached  
 CFB180 Original Brass Burner  
 30" Aluminum Pan with 2" Sidewalls  
 Fire Pit Vent Kit  
 3/4" Flex Line Kit  
 Key Valve Extension  
 Ignition systems available: Push Button, 24 Volt Spark Ignition, 24 Volt Hot  
 Surface Ignition (SC)

SHIPS FREIGHT

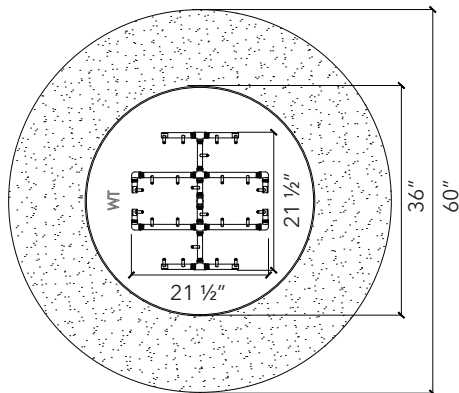

### FC60NG | FC60LP

60" W x 18" H Aluminum Frame with Concrete Board Attached  
 CFB290 Original Brass Burner  
 36" Aluminum Pan with 2" Sidewalls  
 Fire Pit Vent Kit  
 3/4" Dual Flex Line Kit  
 Key Valve Extension  
 Ignition systems available: Push Button, 24 Volt Spark Ignition, 24 Volt Hot  
 Surface Ignition (SC)

SHIPS FREIGHT

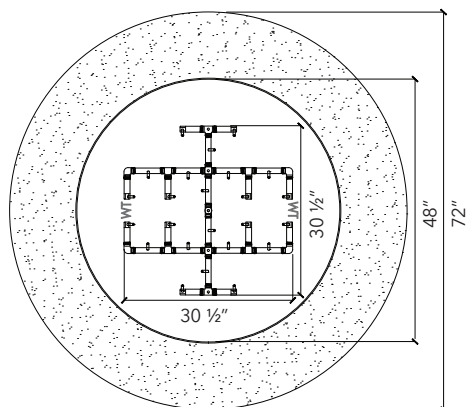

### FC72NG | FC72LP

72" W x 18" H Aluminum Frame with Concrete Board Attached  
 CFB350 Original Brass Burner  
 48" Aluminum Pan with 2" Sidewalls  
 Fire Pit Vent Kit  
 3/4" Dual Flex Line Kit  
 Key Valve Extension  
 Ignition systems available: 24 Volt Spark Ignition, 24 Volt Hot Surface  
 Ignition (HC)

SHIPS FREIGHT

# SQUARE READY-TO-FINISH KITS

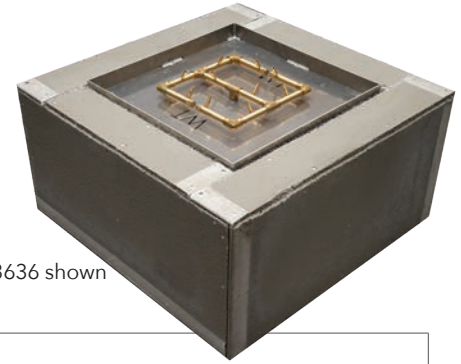

FS3636 shown

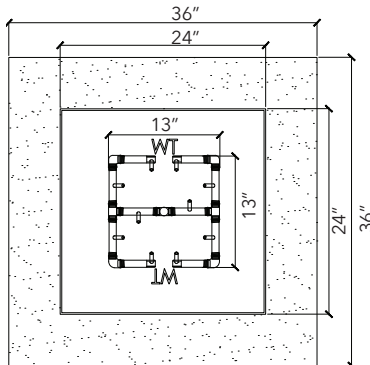

## FS3636NG | FS3636LP

36" x 36" W x 18" H Aluminum Frame with Concrete Board Attached  
 CFB120 Original Brass Burner  
 24" Aluminum Pan with 2" Sidewalls  
 Fire Pit Vent Kit  
 3/4" Flex Line Kit  
 Key Valve Extension  
 Ignition systems available: Push Button, 3 Volt, 24 Volt Spark Ignition,  
 24 Volt Hot Surface Ignition (SC)

SHIPS FREIGHT

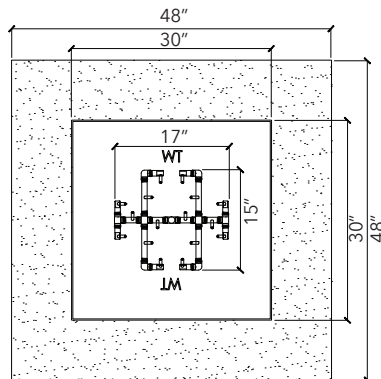

## FS4848NG | FS4848LP

48" x 48" W x 18" H Aluminum Frame with Concrete Board Attached  
 CFB180 Original Brass Burner  
 30" Aluminum Pan with 2" Sidewalls  
 Fire Pit Vent Kit  
 3/4" Flex Line Kit  
 Key Valve Extension  
 Ignition systems available: Push Button, 24 Volt Spark Ignition, 24 Volt Hot  
 Surface Ignition (SC)

SHIPS FREIGHT

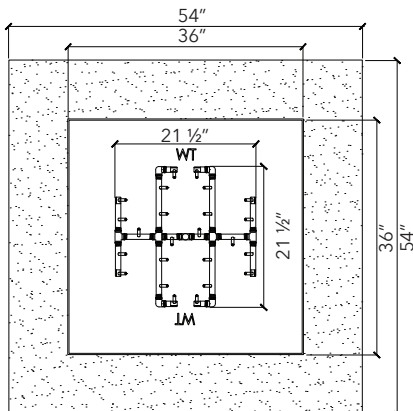

## FS5454NG | FS5454LP

54" x 54" W x 18" H Aluminum Frame with Concrete Board Attached  
 CFB290 Original Brass Burner  
 36" Aluminum Pan with 2" Sidewalls  
 Fire Pit Vent Kit  
 3/4" Dual Flex Line Kit  
 Key Valve Extension  
 Ignition systems available: Push Button, 24 Volt Spark Ignition, 24 Volt Hot  
 Surface Ignition (SC)

SHIPS FREIGHT

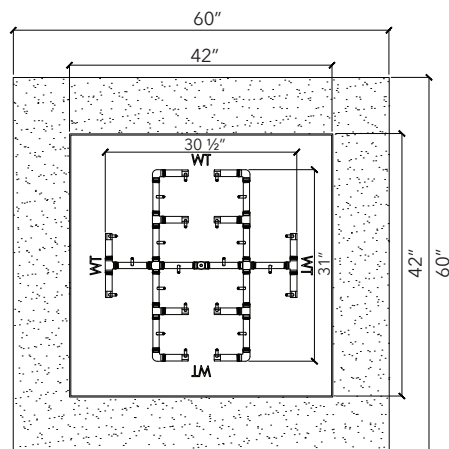

## FS6060NG | FS6060LP

60" x 60" W x 18" H Aluminum Frame with Concrete Board Attached  
 CFB300 Original Brass Burner  
 42" Aluminum Pan with 2" Sidewalls  
 Fire Pit Vent Kit  
 3/4" Dual Flex Line Kit  
 Key Valve Extension  
 Ignition systems available: 24 Volt Spark Ignition, 24 Volt Hot Surface  
 Ignition (HC)

SHIPS FREIGHT





## UNIVERSAL PAVER KITS

---

Universal Paver Kits are specifically designed to work with a variety of paver company block kits, including Techo-Bloc, Belgard, Keystone, and many others.

Please confirm interior dimensions of your pit and choose the corresponding Universal Paver Kit for your project.

Questions? We're happy to help. Call our Flame Consultants at 877 556 5255



# UNIVERSAL PAVER KITS

Warming Trends Universal Paver Kits include everything needed to complete or convert your paver fire pit.

Included in each kit:

- CROSSFIRE® Brass Burner
- Aluminum Plate
- Flex Line Kit
- Key Valve Extension
- Flexible Metal Support Collars

Select the Warming Trends Universal Paver Kit that matches the interior dimensions of your fire pit.

Questions? Want to customize your kit?  
Give us a call at 877 556 5255

UNIVERSAL PAVER KITS

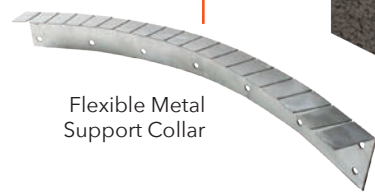
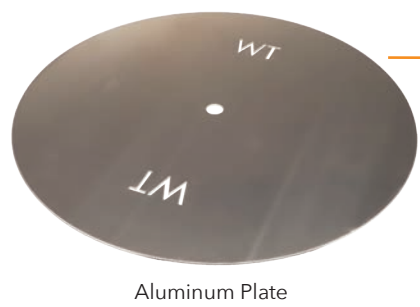
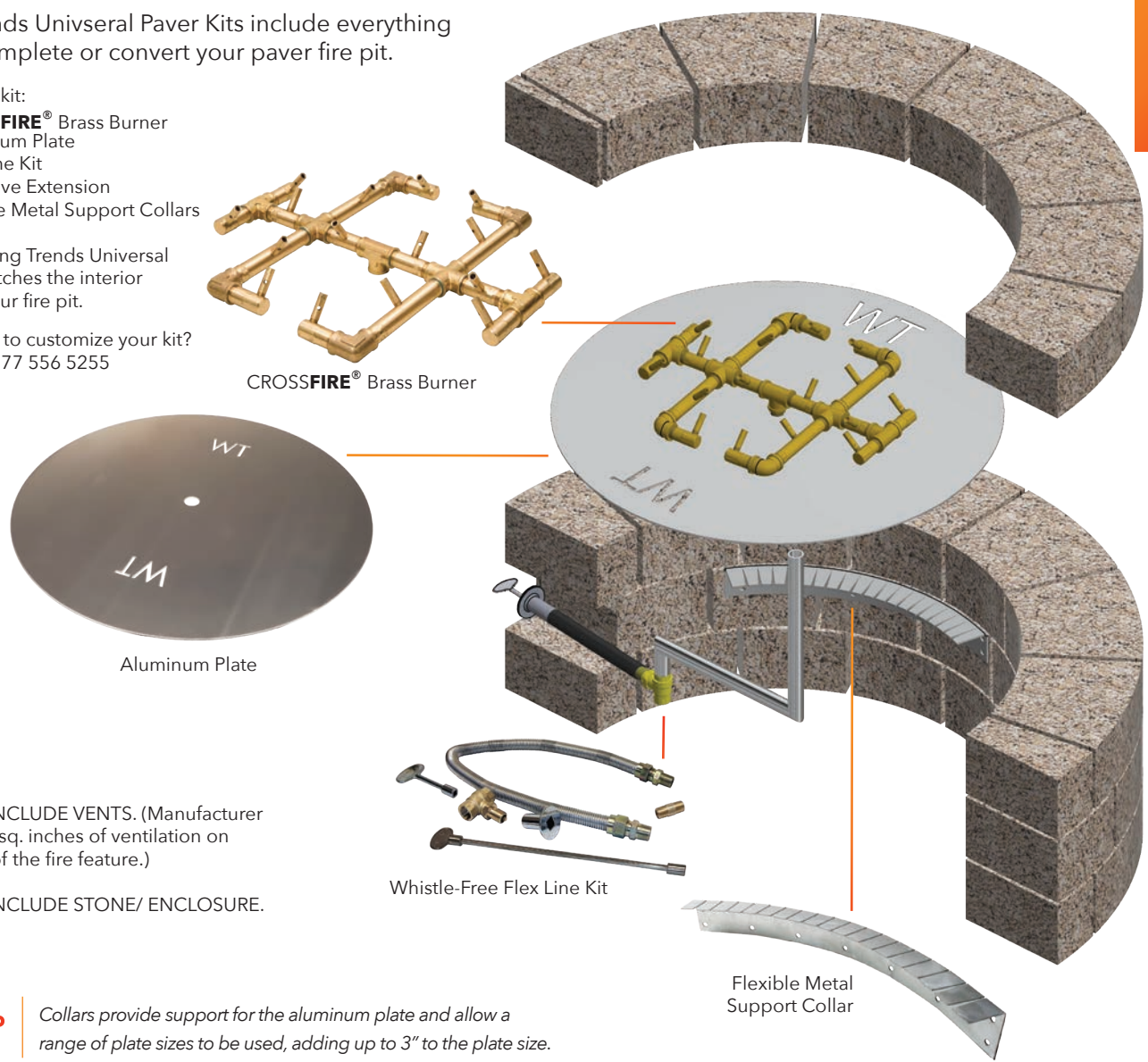

KIT DOES NOT INCLUDE VENTS. (Manufacturer recommends 18 sq. inches of ventilation on opposing sides of the fire feature.)

KIT DOES NOT INCLUDE STONE/ ENCLOSURE.

**TECH TIP** | Collars provide support for the aluminum plate and allow a range of plate sizes to be used, adding up to 3" to the plate size.



## FLEXIBLE METAL SUPPORT COLLAR

COLLAR	19" Flexible Metal Support Collar	3 lbs	19" x 15" x 5"
--------	-----------------------------------	-------	----------------

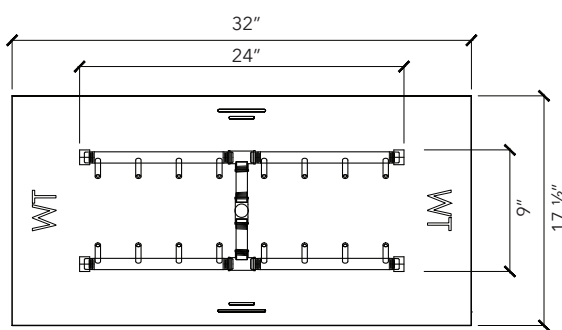

## 17 1/2" x 32" to 20 1/2" x 35" RECTANGULAR OPENING

<b>UPK160H3217NG   UPK160H3217LP</b>	
CFBH160 H-Style Brass Burner 17 1/2" x 32" Rectangular Aluminum Plate 3/4" Flex Line Kit Key Valve, Key Valve Extension, Key (5) Collars	34 lbs 36" x 23" x 12"

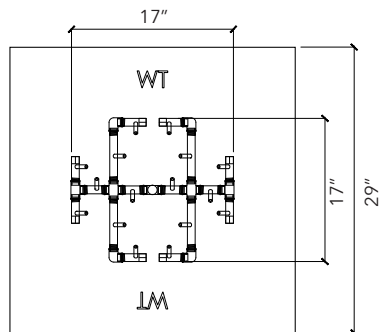
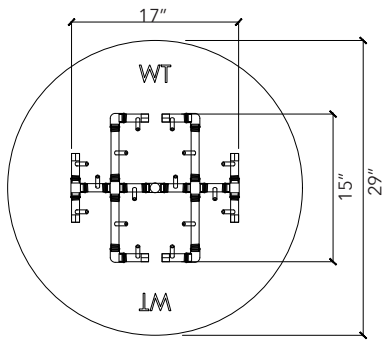
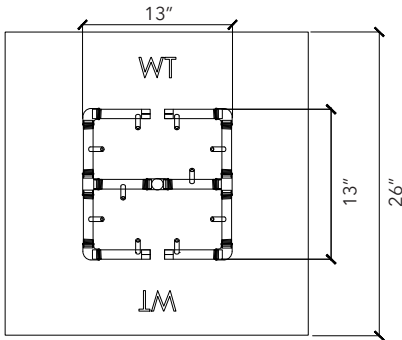
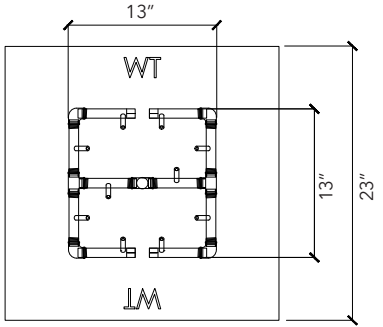
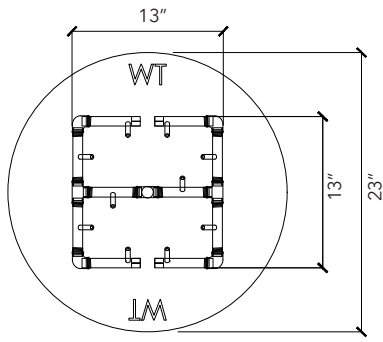

## 23" - 25" CIRCULAR OR SQUARE OPENING

### UPK120C23NG | UPK120C23LP

CFB120 Original Brass Burner 23" Circular Aluminum Plate ¾" Flex Line Kit Key Valve Extension (4) Collars	21 lbs 25" x 25" x 7"
---	--------------------------

### UPK120S23NG | UPK120S23LP

CFB120 Original Brass Burner 23" Square Aluminum Plate ¾" Flex Line Kit Key Valve Extension (4) Collars	21 lbs 26" x 26" x 7"
---	--------------------------

## 26" - 28" SQUARE OPENING

### UPK120S26NG | UPK120S26LP

CFB120 Original Brass Burner 26" Square Aluminum Plate ¾" Flex Line Kit Key Valve Extension (4) Collars	22 lbs 29" x 29" x 7"
---	--------------------------

## 29" - 31" CIRCULAR OR SQUARE OPENING

### UPK180C29NG | UPK180C29LP

CFB180 Original Brass Burner 29" Circular Aluminum Plate ¾" Flex Line Kit Key Valve Extension (5) Collars	28 lbs 31" x 31" x 7"
---	--------------------------

### UPK180S29NG | UPK180S29LP

CFB180 Original Brass Burner 29" Square Aluminum Plate ¾" Flex Line Kit Key Valve Extension (5) Collars	30 lbs 33" x 33" x 7"
---	--------------------------

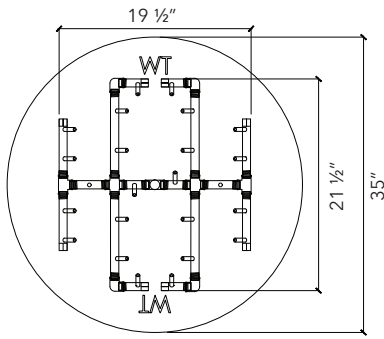

## 35" - 37" CIRCULAR OR SQUARE OPENING

### UPK240C35NG | UPK240C35LP

CFB240 Original Brass Burner  
 35" Circular Aluminum Plate  
 3/4" Flex Line Kit  
 Key Valve Extension  
 (6) Collars

41 lbs  
 37" x 37" x 7"

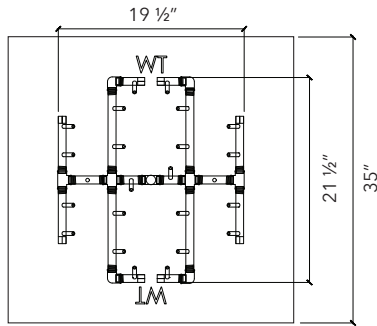

### UPK240S35NG | UPK240S35LP

CFB240 Original Brass Burner  
 35" Square Aluminum Plate  
 3/4" Flex Line Kit  
 Key Valve Extension  
 (6) Collars

47 lbs  
 39" x 39" x 7"

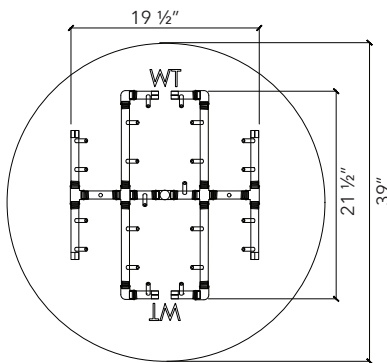

## 39" - 41" CIRCULAR OR SQUARE OPENING

### UPK240C39NG | UPK240C39LP

CFB240 Original Brass Burner  
 39" Circular Aluminum Plate  
 3/4" Flex Line Kit  
 Key Valve Extension  
 (7) Collars

SHIPS FREIGHT

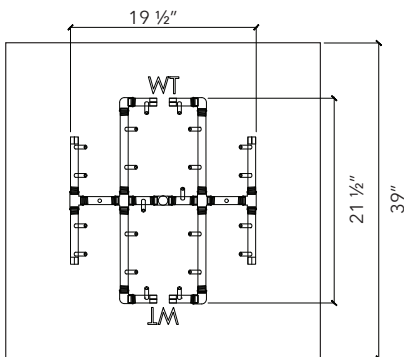

### UPK240S39NG | UPK240S39LP

CFB240 Original Brass Burner  
 39" Square Aluminum Plate  
 3/4" Flex Line Kit  
 Key Valve Extension  
 (7) Collars

SHIPS FREIGHT

## ACCESSORIES

Upgrade to electronic ignitions and turn your fire feature on at the flip of a switch (page 61.)

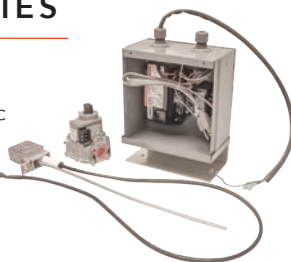

Add a Dial Timer with automatic shut off (page 64.)



Complete the look of your fire feature with glass, lava, or steel or ceramic log sets (page 66.)





## **IGNITIONS, PARTS, ACCESSORIES, & MEDIA**

---

Light your fire feature with the simplicity of a match or choose a fully automatic ignition system.

Select the right accents to complement your feature's surroundings. Complete with a cover made to fit (page 47.)



## IGNITION SYSTEMS



### MATCH LIT

All CROSSFIRE Brass Burners come standard as a manual Match Lit System. Light a match and turn the key valve to ignite your fire feature burner.



### PUSH BUTTON IGNITION

Upgrade to an electric Push Button Ignition. Turn the key valve to on position and push the button to ignite your burner.

SKU	DESCRIPTION	SHIP WEIGHT + DIMS	
PBIK3.0	Push Button Ignition Kit: Spark Igniter Rod and Wire + Push Button Battery Operated Control Module	2 lbs	7" x 7" x 5"
PBIK3.0MBRKV12	Push Button Ignition Kit + Mounting Bracket + 1/2" Key Valve + (2) Pre-mounted 1/2" Street Elbows	2 lbs	11" x 11" x 5"
PBIK3.0MBRKV34	Push Button Ignition Kit + Mounting Bracket + 3/4" Key Valve + (2) Pre-mounted 3/4" Street Elbows	2 lbs	11" x 11" x 5"
PBIK3.0MBRFK1	Push Button Ignition Kit + Mounting Bracket + 3/4" Flex Line Kit + (2) Pre-mounted 3/4" Street Elbows	5 lbs	13" x 13" x 5"
PBIK3.0MBRFK2	Push Button Ignition Kit + Mounting Bracket + 3/4" Dual Flex Line Kit + (2) Pre-mounted 3/4" Street Elbows	7 lbs	15" x 15" x 5"
Replacement Parts			
PB-SI	Spark Igniter Rod and Wire	2 lbs	7" x 7" x 5"
PB-CM	Push Button Battery Operated Control Module	2 lbs	7" x 7" x 5"
MBR	Mounting Bracket with (2) Pre-mounted 3/4" Street Elbows	3 lbs	11" x 11" x 5"

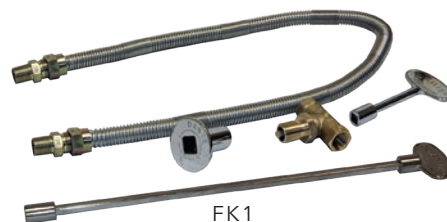

FK1

3/4" Flex Line Kit included in the PBIK3.0MBRKV1

For use with any burner 249K BTUs and below.



FK2

3/4" Dual Flex Line Kit included in the PBIK3.0MBRFK2

For use with any burner 250K BTUs and above.



## 3 VOLT IGNITION

A battery-operated ignition system with on and off switch. 3 Volt Ignition supplies up to 120K BTUs. Remote control available.

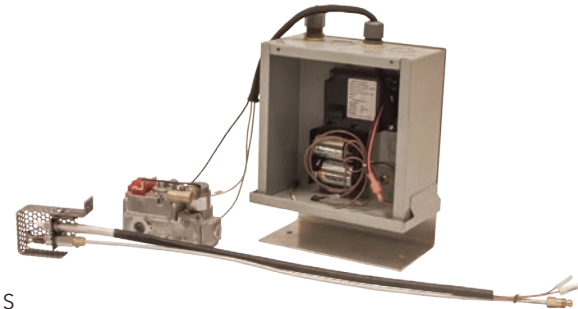

3VIK

SKU	DESCRIPTION	SHIP WEIGHT + DIMS	
3VIK-NG 3VIK-LP	3 Volt Electronic Ignition System: Spark Igniter + Control Module + D-Cell Battery Pack + 3 Volt Gas Valve + up to 120K BTU + Ignition Switch	2 lbs	7" x 7" x 5"
Replacement Parts			
3VCM	3 Volt Control Module	2 lbs	7" x 7" x 5"
3VPA-NG 3VPA-LP	3 Volt Pilot Assembly (Pilot Tube + Igniter + Spark Wire + Igniter Bracket + Wind Cage)	2 lbs	11" x 11" x 5"
3VGV-NG 3VGV-LP	3 Volt 120K BTU Capacity Gas Valve	2 lbs	7" x 7" x 5"
3VBP	3 Volt Battery Pack	2 lbs	7" x 7" x 5"
3VSTEP	3 Volt Step Down Transformer	2 lbs	7" x 7" x 5"
MBR	Mounting Bracket for toggle switch	2 lbs	11" x 11" x 5"



See 3 Volt remote option on page 64.



## 24 VOLT SPARK IGNITION

24 Volt Spark Ignition supplies up to 400K BTUs. Includes step down transformer for use with 24 Volt/110 Volt supply. Remote control options available.

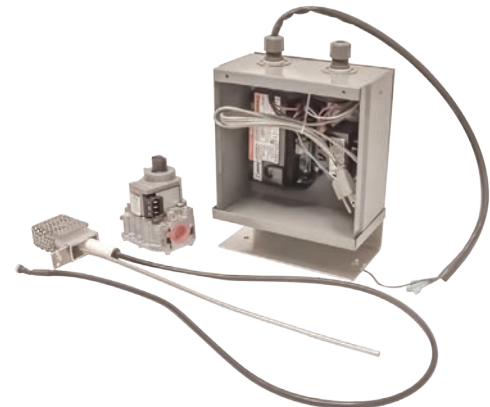

24VIKHC

SKU	DESCRIPTION	SHIP WEIGHT + DIMS	
24VIKHC-NG 24VIKHC-LP	24 Volt Spark Ignition System: Spark Igniter + Control Module + 24 Volt Transformer + up to 400K BTU	17 lbs	13" x 13" x 13"
Replacement Parts			
24VGVHC-NG 24VGVHC-LP	24 Volt Spark Ignition 400K BTU Capacity Gas Valve	5 lbs	7" x 7" x 5"
24VCM	24 Volt Spark Ignition Control Module for use with 24 Volt Spark Ignition System	2 lbs	7" x 7" x 5"
24VPA-NG 24VPA-LP	24 Volt Spark Ignition Pilot Assembly (Pilot Tube + Igniter + Spark Wire + Igniter Bracket + Wind Cage) for use with 24 Volt Spark Ignition System	2 lbs	13" x 13" x 5"
24VT	For use with all 24 Volt Ignition Systems (Spark Ignition or Hot Surface Ignition)	5 lbs	7" x 7" x 5"



Remote options available on page 64.



## 24 VOLT HOT SURFACE IGNITION

24 Volt Hot Surface Ignition Standard Capacity supplies up to 290K BTUs.  
 24 Volt Hot Surface Ignition High Capacity supplies up to 512K BTUs.  
 Includes step down transformer for use with 24 Volt/110 Volt supply.  
 Remote control options available.

SKU	DESCRIPTION	SHIP WEIGHT + DIMS	
P24VIKSCCG-NG P24VIKSCCG-LP	24 Volt Hot Surface Ignition System - Standard Capacity: Hot Surface Igniter + 50VA/24VAC Transformer + Maximum Gas Output 290K BTU/hr	18 lbs	13" x 13" x 13"
P24VIKHCCG-NG P24VIKHCCG-LP	24 Volt Hot Surface Ignition System - High Capacity: Hot Surface Igniter + 50VA/24VAC Transformer + Maximum Gas Output 512K BTU/hr	18 lbs	13" x 13" x 13"
Replacement Parts			
P24VCBSC	24 Volt 290K BTU Standard Capacity Hot Surface Ignition Control Box with Single Pilot Connections	2 lbs	8" x 8" x 8"
P24VCBHC	24 Volt 512K BTU High Capacity Hot Surface Ignition Control Box with Single Pilot Connections	2 lbs	8" x 8" x 8"
24VT	24 Volt Transformer for use with all 24 Volt Ignition Systems (Spark & Hot Surface Ignitions)	5 lbs	7" x 7" x 5"
P24VIKWC	Wind Cage	2 lbs	7" x 7" x 5"
P24VIKCGPA-NG P24VIKCGPA-LP	24 Volt Hot Surface Ignition Pilot Assembly (Dual Pilot Tubes + Igniter + Igniter Bracket + Wind Cage) for use with Hot Surface Ignition Systems (Standard & High Capacity)	2 lbs	13" x 13" x 5"
P24VCBSCCG	24 Volt Hot Surface Ignition 290K BTU Standard Capacity Control Box with Dual Pilot Connections	2 lbs	8" x 8" x 8"
P24VCBHCCG	Premium 24 Volt 512K BTU High Capacity Control Box with Dual Pilot Connections	2 lbs	8" x 8" x 8"

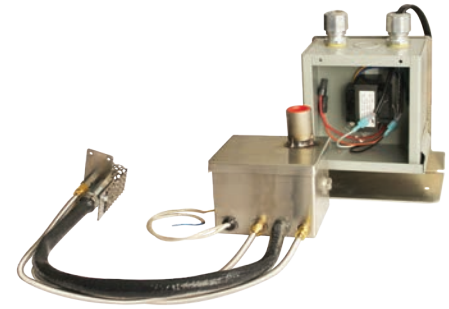

P24VIKSCCG



P24VCBHC



P24VIKCGPA



Dialer timer, emergency stop, and remote options available on page 64.

Low voltage Premium Ignition available. Call a Warming Trends Flame Consultant to discuss the best ignition system for your CROSSFIRE Brass Burner.

### TECH TIP

Aluminum covers help protect electronic ignition systems from the elements.  
 Available in standard and custom sizes. Custom and standard sizes available, page 47.

## ELECTRONIC ACCESSORIES

Want to turn your fire feature on remotely? We've got you covered. Electronic accessories that keep your fire feature safe and easy to use.



### 3 VOLT REMOTE

SKU	DESCRIPTION	SHIP WEIGHT + DIMS	
3VRC	ON/OFF Remote Control for 3 Volt Ignition System	4 lbs	7" x 7" x 5"



### 24 VOLT KEY CHAIN REMOTE

SKU	DESCRIPTION	SHIP WEIGHT + DIMS	
KCRC	ON/OFF Wireless Key Chain Remote Control & Plug In Receiver for 24 Volt Ignition System	4 lbs	11" x 11" x 5"



### DIAL TIMERS

Available in 2 hour and 12 hour options for automatic shut off, with or without NEMA Rated outdoor enclosure.

SKU	DESCRIPTION	SHIP WEIGHT + DIMS	
DT2HR	2 Hour Dial Timer	2 lbs	7" x 7" x 5"
DT2HRNB	2 Hour Dial Timer with NEMA Rated Enclosure	5 lbs	8" x 8" x 8"
DT12HR	12 Hour Dial Timer	2 lbs	7" x 7" x 5"
DT12HRNB	12 Hour Dial Timer with NEMA Rated Enclosure	2 lbs	8" x 8" x 8"



### EMERGENCY STOP

SKU	DESCRIPTION	SHIP WEIGHT + DIMS	
EMERSTOP	Push Button Emergency Stop with yellow shell and weatherproof lift cover. Recommended for commercial properties.	5 lbs	11" x 11" x 5"

**TECH TIP** | Typically commercial projects require an Emergency Stop and electronic ignition. Consult your local code.



## PARTS

SKU	DESCRIPTION	SHIP WEIGHT + DIMS	
FK1	For use with any burner 249K BTUs and below. Kit includes: (1) 36" L x 3/4" Diameter Flex Line + 3/4" Key Valve + 3" Key and 12" Key + (1) 1/2" x 2" Nipple	3 lbs	13" x 13" x 5"
FK2	For use with any burner 250K BTUs and above. Kit includes: (2) 36" L x 3/4" Diameter Flex Line + 3/4" Key Valve + 3" Key and 12" Key + (2) 3/4" x 3" Nipple + (2) 3/4" Tee + (1) 3/4" x 1/2" Male Reducing Fitting	7 lbs	13" x 13" x 5"
FIT180	Flex Line & Key Valve Connection Fitting for use with any 121K - 249K BTU Burner. Kit includes: (1) 1/2" x 2" Nipple.	3 lbs	4" x 4" x 4"
FIT250	Flex Line & Key Valve Connection Fittings for use with any burner 249K - 299K BTU. Kit includes: (1) 3/4" x 1/2" MM Reducer Fitting + (2) 3/4" Tee + (1) 3/4" x 3" Nipple.	4 lbs	7" x 7" x 5"
FIT300	Flex Line & Key Valve Connection Fittings for 300k+ BTU Burner. Kit includes: (2) 3/4" x 3" Nipple + (2) 3/4" Tee.	2 lbs	7" x 7" x 5"
REDUCER3412	Reducer 3/4" Male x 1/2" Male Fitting	2 lbs	4" x 4" x 4"
FL3612	36" L x 1/2" Diameter Flex Line (MM)	2 lbs	11" x 11" x 5"
FL3634	36" L x 3/4" Diameter Flex Line (MM)	5 lbs	11" x 11" x 5"
KV12	1/2" Key Valve + 3" Key	2 lbs	7" x 7" x 5"
KV34	3/4" Key Valve + 3" Key	2 lbs	7" x 7" x 5"
KEY12	12" Key	3 lbs	13" x 13" x 5"
KEY24	24" Key	2 lbs	25" x 5" x 5"
KVE	6 - 12" Key Valve Extension	2 lbs	13" x 13" x 5"
DRIPLEG12	1/2" Drip Leg Kit	2 lbs	11" x 11" x 5"
DRIPLEG34	3/4" Drip Leg Kit	2 lbs	11" x 11" x 5"
LPRH	Liquid Propane Regulator mounted on 5/16" (internal diameter) 10' Hose with handwheel quick connect. For use up to 200K BTUs with a 20LB Propane Tank.	4 lbs	11" x 11" x 5"
LPHOSE10	LP 5/16" (internal diameter) 10' Hose. For use with a 20lb propane tank	2 lbs	11" x 11" x 5"
REGLP200	Regulator 3/8" in. NPT Female Outlet 200K BTU/hr capacity. Maximum inlet pressure 250 psi. Low pressure outlet 11 in. W.C. Liquid Propane	2 lbs	7" x 7" x 5"
ACCESSUA1414	Access panel: 16" x 16" exterior frame and 14" x 14" door opening for easy access to interior of fire feature	2 lbs	19" x 19" x 7"
FPVK	Fire Pit Vent Kit: (2) 12" x 4" Vents + 18 square inches of vent area per vent	2 lbs	13" x 13" x 5"
COLLAR	Paver Kit Adjustable Install Collar 19" + (6) Screws	2 lbs	19" x 15" x 5"

# MEDIA

## LAVA ROCK



### BLR

1" - 1 1/2" Black Lava Rock,  
1 bag per 1 cubic foot



### LRR

1" - 2" Gray/Black Rolled  
Lava, 1 bag per 1 cubic foot

## FIRE GLASS

### TECH TIP

Easily calculate how much lava rock or fire glass will be needed with the Fire Glass calculator on our website.

3/4" Fire Glass. Colors may vary from photo.

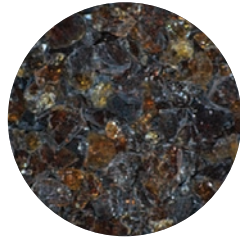

**CS AMBER 9**  
Dark Amber



**CS AMBER 4**  
Light Amber



**BURNT ORANGE**  
Burnt Orange



**CA RED**  
Red

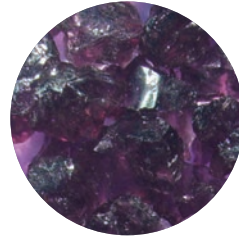

**MN PURPLE 4**  
Purple

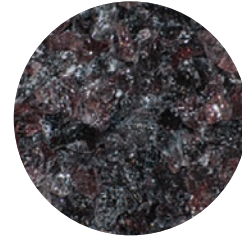

**PLUM 7**  
Plum

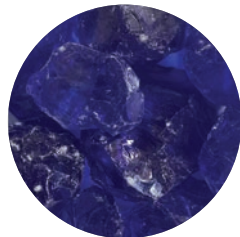

**CO BLUE 5**  
Dark Blue

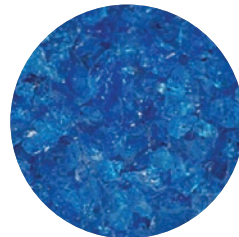

**CO BLUE 3**  
Light Blue

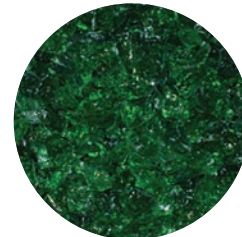

**CR GREEN 6**  
Dark Green



**CR GREEN 4**  
Light Green

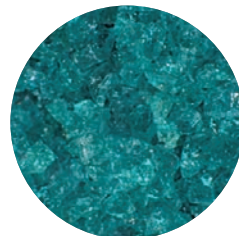

**AQUA 2**  
Aqua

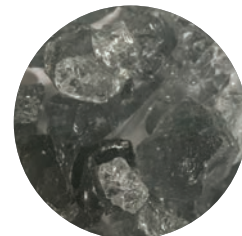

**GRAY 5**  
Gray



**BLACK**  
Black



**CLEAR**  
Clear



Additional Options  
Available Upon Request

## CERAMIC LOG SETS

---



## WESTERN OAK LOG SETS

---

Additional sizes available upon request.

SKU	DESCRIPTION	SHIP WEIGHT	+ DIMS
WOS	Western Oak Log Set for 24" - 30" Fire Pit (8 Pieces)	31 lbs	(1 box) 24" x 13" x 10"
WOM	Western Oak Log Set for 36" - 42" Fire Pit (12 Pieces)	64 lbs	(1 box) 32" x 16" x 11"
WOL	Western Oak Log Set for 48" Fire Pit (15 Pieces)	89 lbs	(1 box) 36" x 16" x 11"



## MOUNTAIN SPLIT LOG SETS

---

Additional sizes available upon request.

SKU	DESCRIPTION	SHIP WEIGHT	+ DIMS
MSS	Mountain Split Log Set for 24" - 30" Fire Pit (8 Pieces)	31 lbs	(1 box) 24" x 13" x 10"
MSM	Mountain Split Log Set for 36" - 42" Fire Pit (12 Pieces)	64 lbs	(1 box) 32" x 16" x 11"
MSL	Mountain Split Log Set for 48" Fire Pit (15 Pieces)	89 lbs	(1 box) 36" x 16" x 11"



## STEEL LOG SETS

Available for 18", 24", 30", and 36" Fire Pits.

SKU	DESCRIPTION	SHIP WEIGHT + DIMS
SLS18	Handcrafted to fit 18" Fire Pit	SHIPS FREIGHT
SLS24	Handcrafted to fit 24" Fire Pit	SHIPS FREIGHT
SLS30	Handcrafted to fit 30" Fire Pit	SHIPS FREIGHT
SLS36	Handcrafted to fit 36" Fire Pit	SHIPS FREIGHT
SLSCUST	Custom Handcrafted Steel Log Set	SHIPS FREIGHT

### TECH TIP

Custom Steel and FireStorm® Log Sets are available. Give us a call at 877 556 5255

## FIRESTORM® STEEL LOG

Handcrafted, one-of-a-kind steel gas log features an integrated burner to create a beautiful flame pattern.

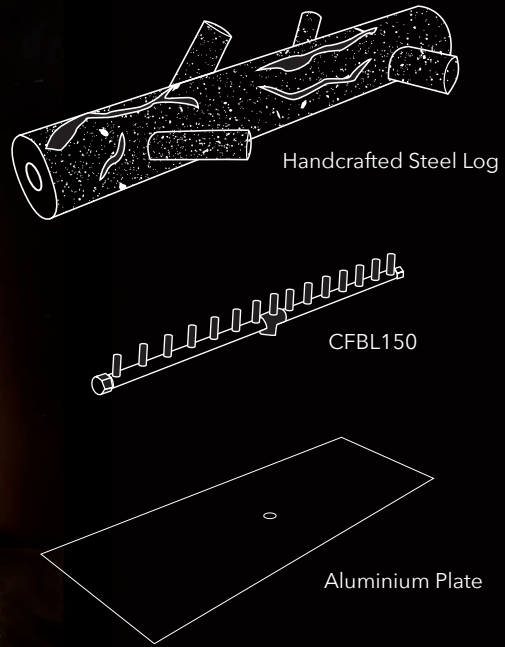
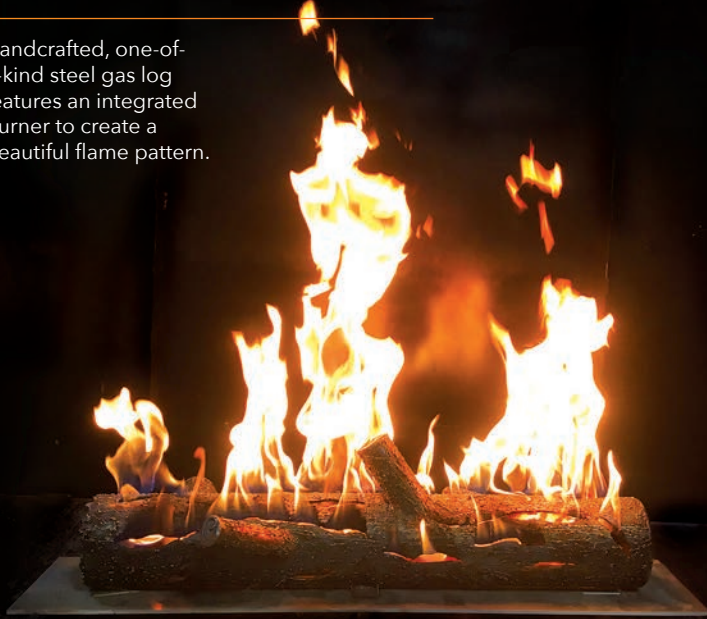

SKU	DESCRIPTION	SHIP WEIGHT + DIMS
FSLS32LP	32" Steel log with integrated CFBL150 CROSSFIRE Brass Burner on a 38" x 10" aluminum plate for Liquid Propane	SHIPS FREIGHT
FSLS32NG	32" Steel log with integrated CFBL150 CROSSFIRE Brass Burner on a 38" x 10" aluminum plate for Natural Gas	SHIPS FREIGHT



## Warranty

### FULL LIFETIME WARRANTY FOR WARMING TRENDS® BURNERS

WARMING TRENDS warrants that each WARMING TRENDS® Crossfire® and other jetted-flame-brass-burners (each as "Burner") is free from defects in materials and workmanship and conforms to its specifications, which are available upon request.

The warranty period for a Burner is lifetime warranty beginning on the date of purchase ("Warranty Period"). This Warranty is transferable, but we reserve the right to require proof of ownership for any transferred burners including proof that the Burner was not acquired through improper means or unauthorized re-sellers. During the Warranty Period, WARMING TRENDS provides repair and exchange services for the Burners, without charge. If a Burner does not function as warranted during the Warranty Period and, after a reasonable number of attempts, WARMING TRENDS is unable to either 1) make it do so or 2) replace it with one that is at least functionally equivalent, you may return it to WARMING TRENDS and your money will be refunded.

The warranty stated above will not apply to the extent that there has been misuse or use contrary to specifications or the appropriate user or operating manual, installation defect, accident, modification, unsuitable physical or operating environment, operation in other than the specified operating environment (e.g., outdoor burners should only be used outdoors) improper maintenance by you, or failure caused by a product for which WARMING TRENDS is not responsible. With respect to Burners, the warranty is voided by removal or alteration of any identification labels or marks on any Burner or part.

THESE WARRANTIES ARE YOUR EXCLUSIVE WARRANTIES AND REPLACE ALL OTHER WARRANTIES OR CONDITIONS, EXPRESS OR IMPLIED, INCLUDING, BUT NOT LIMITED TO, THE IMPLIED WARRANTIES OR CONDITIONS OF MERCHANTABILITY AND FITNESS FOR A PARTICULAR PURPOSE.

#### ITEMS NOT COVERED BY WARRANTY

Other than as expressly stated above, WARMING TRENDS does not warrant uninterrupted or error-free operation of any Burner or that WARMING TRENDS will correct all defects.

Warming Trends does not warranty any services related to our Burners, including installation, unless we provided those services to you. You may have warranty rights from the service provider, but we make no representations or warranties express or implied regarding any third party service provider.

This warranty also does not apply to any fire logs (including the FireStorm® Steel Log) or any of the electronics used in connection with our Burners, which may be covered by separate warranties with different terms.

#### YOUR RIGHTS UNDER STATE LAW

This Warranty gives you specific legal rights, and you may also have other rights which vary from state to state. You may find this information from the Federal Trade Commission helpful in understanding your rights, but we recommend you speak to your attorney regarding your specific situation and the laws in your state or jurisdiction. <https://www.consumer.ftc.gov/articles/0252-warranties>

## Ignition Systems Warranty

### ALL BURNERS AND ELECTRONICS MUST BE COVERED WHEN NOT IN USE OR WARRANTY IS NULL AND VOID

**Push Button Ignition Systems:** There is no warranty offered on any push button ignition system.

#### Electronic Ignition Systems:

##### Residential Installations:

- 24VIK and 3VIK systems are fully warranted for one (1) year with a limited warranty for two (2) years from date of purchase. In the event a system must be replaced due to a defect/malfunction of the system, Warming Trends will repair or replace the system at no cost for the first year. In the event a system fails after the first year from date of purchase and within two years from date of purchase, Warming Trends will repair or replace the system for a cost of 50% of the current list price. This warranty does not cover labor costs.
- P24VIK systems purchased ON OR BEFORE April 15, 2018 are fully warranted for one (1) year with a limited warranty for two (2) years from date of purchase. In the event a system must be replaced due to a defect/malfunction of the system, Warming Trends will repair or replace the system at no cost for the first year. In the event a system fails after the first year and within two years of date of purchase, the cost for a replacement system is at a discount rate of 50% of the current listed price. This warranty does not cover labor costs.
- P24VIK Systems purchased AFTER April 15, 2018 are fully warranted for three (3) years from date of purchase. In the event a system must be replaced due to a defect/malfunction of the system, Warming Trends will repair or replace the system at no cost for the first three years. This warranty does not cover labor costs.

##### Commercial Installations:

- 24VIK and 3VIK systems are fully warranted for twelve months from date of purchase. In the event a system must be replaced due to a defect/malfunction of the system, Warming Trends will repair or replace the system at no cost. This warranty does not cover labor costs.
- P24VIK Systems are fully warranted for one (1) year from date of purchase. In the event a system must be replaced due to a defect/malfunction of the system, Warming Trends will repair or replace the system at no cost for 12 months from the date of purchase. This warranty does not cover labor costs.

Problems in the functioning of the systems due to gas plumbing or electrical installed by others are not covered by any warranty offered by Warming Trends.

No dealer, distributor, or other person has the authority to represent or warrant a Warming Trends™ product beyond the terms contained within this warranty, and Warming Trends assumes no liability for such warranty representations. Any questions concerning this warranty should be directed to the Warming Trends™ corporate office.

#### Return Policy of Warranty Product

Any Warming Trends™ product deemed by Warming Trends™ as defective and covered by the warranty may be returned to Warming Trends™ for assessment to determine if repair or replacement is necessary. In order to return a product, you must have a Return Merchandise Authorization number (RMA#). Please contact a Warming Trends™ representative at the corporate office to obtain an RMA#. All returned merchandise must have the RMA# clearly printed on the outside of the package. Return shipping costs are the purchaser's responsibility. Warming Trends™ is not responsible for product damaged or lost in transit. It is recommended that return items are shipped via a delivery service that can be tracked and/or insured to confirm receipt.



# WARMING TRENDS®

## Live Burn Displays



### Counter Top Display

Counter Top Displays includes a 17" tall triangle brushed aluminum base which holds a removable CFB60 CROSSFIRE Brass Burner on a 12" plate. The unit is ready to connect to a 1lb propane tank. This display is great for small spaces and the removable demo burner is the perfect portable sales tool.

**The top reason consumers prefer to shop in-store versus online is to see, feel and experience the product in person.\***

Let your customers experience the performance of a Warming Trends CROSSFIRE Brass Burner.

### Floor Display

The Floor Display is 30" tall and 18" square. The display includes a hollow metal frame, choice of four slide-in marketing panels, a plate with a mounted key valve, and a CFB60 CROSSFIRE Brass Burner. The unit is ready to connect to a 1lb propane tank (and can be modified to connect up to a 20 lb tank.) Perfect for a showroom display.

**To order, please contact us at**

orders@warming-trends.com or 877-556-5255.



\*Hearth and Home 1/29/20, The Balance Small Business 6/25/19, V12 Data 2/27/19





# WARMING TRENDS<sup>®</sup>

[www.Warming-Trends.com](http://www.Warming-Trends.com) | 303 346 2224

**PATENTED**  
[www.warming-trends.com/patents](http://www.warming-trends.com/patents)

Proud Member of

