



the **outdoor**  
**greatroom**  
company

**2023 CATALOG**



Bring Home Outside.

**4**  
ABOUT  
5 Photography Program

**7**  
GAS FIRE PIT TABLES  
8 Linear Tables  
11 Rectangular Tables  
13 Round Tables  
15 Square Tables

**17**  
READY-TO-FINISH

**23**  
ACCESSORIES

**27**  
FURNITURE

**33**  
CUSTOM CAPABILITIES  
34 Finishes  
35 Finishes Chart  
36 Fire Features  
37 Our Process  
38 Kitchens

**41**  
BURNERS & KITS  
42 Linear Burners  
44 Round Burners  
45 Square Burners  
46 Controls  
47 Do-it-Yourself Kits

**30**  
INTRIGUE

**49**  
CONTRACT & COMMERCIAL  
51 Linear DSI Burners  
52 Round DSI Burners  
53 Square DSI Burners  
54 DSI Controls  
55 Wave Burner

**57**  
REFERENCES  
58 Accessory Glossary  
62 Standard Materials  
63 Custom Forms  
67 Warranty  
68 FAQs  
70 Contact



## Who We Are

Located in the heart of Minnesota, The Outdoor GreatRoom Company™ (OGC) manufactures unique, upscale products with design appeal for outdoor living spaces. Products include gas fire pit tables, Crystal Fire® Plus burners and burner inserts, outdoor kitchen islands, outdoor gas fireplaces, outdoor patio furniture, accessories, and custom products for residential and commercial applications.

## What We Do

The team behind The Outdoor GreatRoom Company was the first to enter into the gas fire pit category, positioning OGC as the experts on outdoor fire. We are U.S. manufacturers and all of our Crystal Fire® Plus burners and gas fire pit tables are UL and ULC listed for safety.

## Our Promise

Let The Outdoor GreatRoom Company help to define your outdoor experience. We set the trends outside as your one-stop-shop for safe products, reliable and friendly service, and innovative technology. From concept to design to delivery, we will ensure your style doesn't stop at the door. Distinctive products for a distinctive lifestyle. Bring home outside.

## Our Mission

To bring family and friends together by redefining the home living experience through innovative products and people.

## History

In 1975, Dan and Ron Shimek had an inspiration for indoor gas fireplaces that changed an industry and became the foundation of Heat-N-Glo®. Brothers Steve and Gerry joined them and the rest (including over 50 patents) is history. But the Shimeks were never ones to dwell on the past. That inspiration led Dan to launch the first company of its kind in 2003: The Outdoor GreatRoom Company — a company dedicated to an exciting new concept “the outdoor greatroom.”

## Why OGC?

OGC is focused on bringing the best and safest product to the market. That's why we have a team with over 20 years of experience manufacturing products in the outdoor living category, and we continue to introduce the best and most innovative products year after year.

### Crystal Fire® Plus Burner Technology

The safest and most reliable in the industry.

### UL & ULC Listed

Tested for safety and quality.

### Design-Forward Products

Handcrafted in Minnesota from durable, outdoor-rated materials.

### We're Like Family

We provide exceptional customer service and reliability.



## Photography Program

- Become a photographer! The Outdoor GreatRoom Company is always on the lookout for quality images that represents OGC's products and the lifestyle it has to offer.
- Have an amazing outdoor scene featuring OGC products you'd like to show off? Send us your pictures!
- Most high end smart phones and digital cameras will work.
- If your photos are approved, you may receive up to \$200 in credit for any future purchases.
- Send pictures with name, company name, phone number & sales order # to [marketing@outdoorrooms.com](mailto:marketing@outdoorrooms.com)

### Images Requirements:

- Must be high resolution
- Larger than 2000 x 2000 pixels
- Must be in color
- Must include flame





Light up the night with a cozy, stylish gas fire pit.  
Every table includes our patent-pending Crystal Fire® Plus burner technology  
for the best and safest experience. All fire tables include clear tempered glass gems.



**| GAS FIRE PIT TABLES**



# Gas Fire Pit Tables



DENBR-1242 with optional FWG-1242

## Denali Brew

- Brown Everblend™ concrete top
- Corrugated metal base with mocha wood frame
- 12" x 42" Crystal Fire® Plus burner
- Grey glass burner cover included
- Access door conceals standard 20 lb. propane tank in base
- 65,000/80,000 BTUs (LP/NG)
- Made in USA with US and imported parts

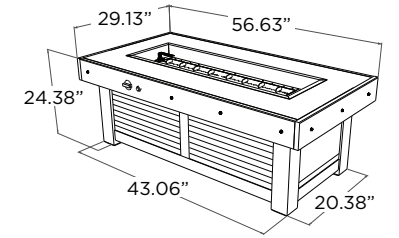

MG-1242-BLSM-K

## Balsam Montego

- Black glass top
- Balsam outdoor resin wicker base
- 12" x 42" Crystal Fire® Plus burner
- Grey glass burner cover included
- Access door conceals standard 20 lb. propane tank in base
- 65,000/80,000 BTUs (LP/NG)

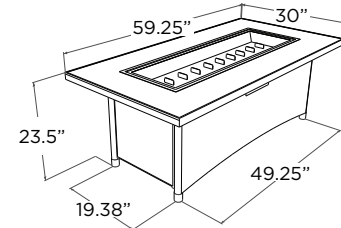

KL-1242-MM

## Grey Key Largo

- Midnight Mist Supercast™ concrete top
- Black Fleck stucco base
- 12" x 42" Crystal Fire® Plus burner
- Grey glass burner cover included
- Sliding access door conceals standard 20 lb. propane tank in base
- 65,000/80,000 BTUs (LP/NG)
- Made in USA with US and imported parts

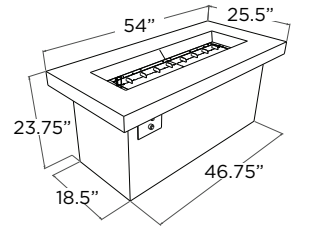

UPT-1242

## Uptown Black

- Black tile with Midnight Mist Supercast™ concrete top
- Midnight Storm stucco base
- 12" x 42" Crystal Fire® Plus burner
- Grey glass burner cover included
- Sliding access door conceals standard 20 lb. propane tank in base
- 65,000/80,000 BTUs (LP/NG)
- Made in USA with US and imported parts

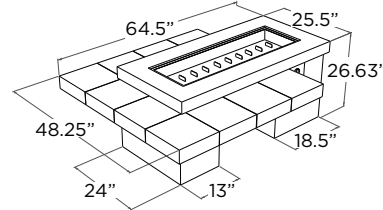

KL-1242-SS with optional GLASS GUARD-1242

## Stainless Steel Key Largo

- Stainless steel trim top
- Black Fleck stucco base
- 12" x 42" Crystal Fire® Plus burner
- Grey glass burner cover included
- Sliding access door conceals standard 20 lb. propane tank in base
- 65,000/80,000 BTUs (LP/NG)
- Made in USA with US and imported parts

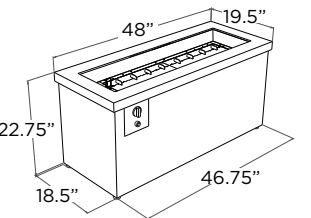

UPT-1242-IRO with optional FWG-1242

## Uptown Iroko

- Iroko wood with linen colored Supercast™ concrete top
- Black aluminum base
- 12" x 42" Crystal Fire® Plus burner
- Grey glass burner cover included
- Sliding access door conceals standard 20 lb. propane tank in base
- 65,000/80,000 BTUs (LP/NG)
- Made in USA with US and imported parts

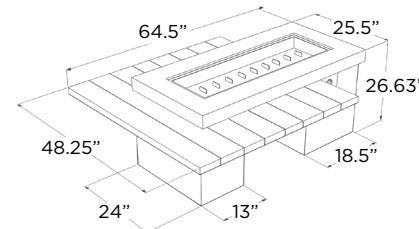

KW-1242-K

## Kenwood Dining

- Umber brown composite decking top and base
- Grey powder-coated aluminum framing
- 12" x 42" Crystal Fire® Plus burner
- Grey glass burner cover included
- Access door conceals standard 20 lb. propane tank in base
- 65,000/80,000 BTUs (LP/NG)

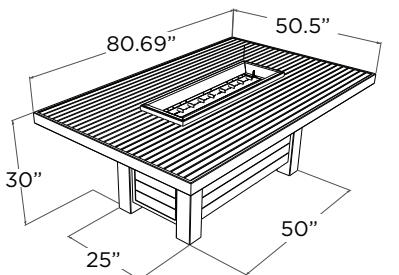

CR-1242-K with optional GLASS GUARD-1242

## Cedar Ridge

- Washed Cedar Supercast™ concrete top
- Dark grey composite decking base
- 12" x 42" Crystal Fire® Plus burner
- Matching Supercast concrete burner cover included
- Access door conceals standard 20 lb. propane tank in base
- 65,000/80,000 BTUs (LP/NG)
- Made in USA with US and imported parts

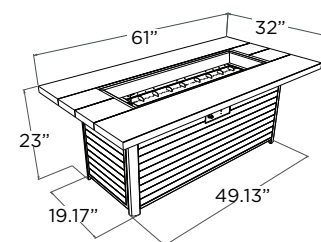

MCR-1242-BLK-K

## Monte Carlo

- Black glass top
- Black powder-coated metal base
- 12" x 42" Crystal Fire® Plus burner
- Grey glass burner cover included
- Sliding access door conceals standard 20 lb. propane tank in base
- 65,000/80,000 BTUs (LP/NG)
- Made in USA with US and imported parts

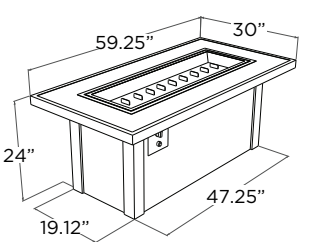



Light up the night.



KN-1224

### Kinney

- Trillium Everblend™ concrete top
- Black powder-coated metal base
- 12" x 24" Crystal Fire® Plus burner
- Grey glass burner cover included (fits inside base)
- Access door conceals horizontal 20 lb. propane tank — does not fit standard 20 lb. tank
- 55,000 BTUs
- Made in USA with US and imported parts

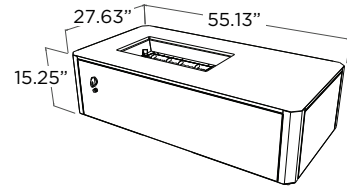

CV-54

### Cove 54"

- Natural Grey, White, or Midnight Mist Supercast™ concrete base
- 7" x 37" Crystal Fire® Plus burner insert inside 12" x 42" plate
- Matching Supercast concrete pedestal included
- Does not fit 20 lb. LP tank in base
- 65,000/80,000 BTUs (LP/NG)
- Made in USA with US and imported parts

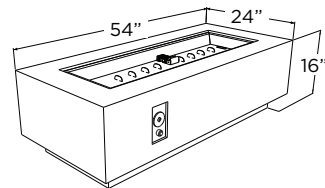

Color options available



CV-72WT

### Cove 72"

- White, Midnight Mist, or Natural Grey Supercast™ concrete base
- 7" x 57" Crystal Fire® Plus burner insert inside 12" x 64" plate
- Matching Supercast concrete pedestal included
- Does not fit 20 lb. LP tank in base
- 100,000 BTUs
- Made in USA with US and imported parts

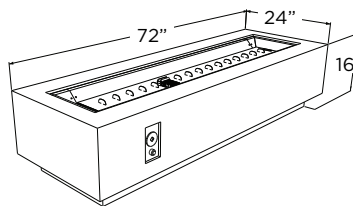

Color options available

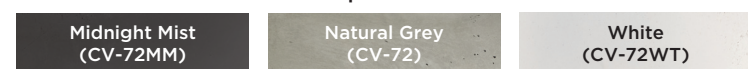

ALC-1224 with optional GLASS GUARD-1224

### Alcott

- Antique Timber Supercast™ concrete top
- Whitewashed shiplap base
- 12" x 24" Crystal Fire® Plus burner
- Matching Supercast concrete burner cover included
- Sliding access door conceals standard 20 lb. propane tank in base
- 55,000 BTUs
- Made in USA with US and imported parts

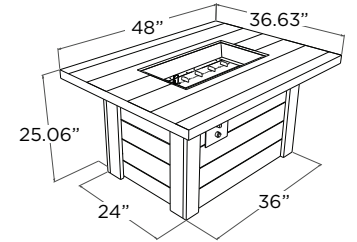

BRK-1224-19-K

### Brooks

- Taupe composite decking top and base
- Grey powder-coated aluminum framing
- 12" x 24" Crystal Fire® Plus burner
- Grey glass burner cover included
- Access door conceals standard 20 lb. propane tank in base when included riser kit is installed on table
- 55,000 BTUs

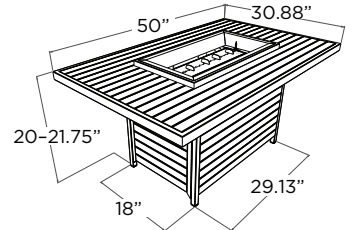

KW-1224-19-K

### Kenwood Chat

- Umber brown composite decking top and base
- Grey powder-coated aluminum framing
- 12" x 24" Crystal Fire® Plus burner
- Grey glass burner cover included
- Access door conceals standard 20 lb. propane tank in base when included riser kit is installed on table
- 55,000 BTUs

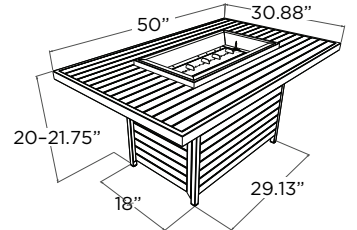

PROV-1224-SS

### Providence

- Stainless steel trim top
- Black powder-coated metal base
- 12" x 24" Crystal Fire® Plus burner
- Grey glass burner cover included
- Access door conceals standard 20 lb. propane tank in base
- 55,000 BTUs
- Made in USA with US and imported parts

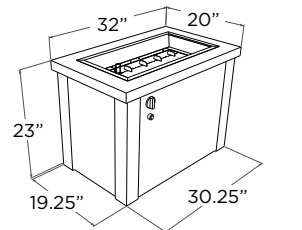



DAR-1224-K

### Darrien

- Aluminum or Stone Grey Everblend™ concrete top
- Grade A teak wood base
- 12" x 24" Crystal Fire® Plus burner
- Matching burner cover included for aluminum top; grey glass cover included for Everblend concrete top
- Access door conceals standard 20 lb. propane tank in base
- 55,000 BTUs

**Top options available**

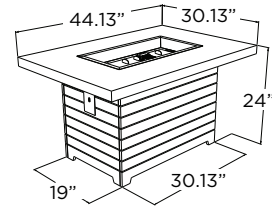

SF-32-K

### Brown Stonefire

- Dora brown composite top
- Brown powder-coated aluminum frame with brown mesh base
- 16" Crystal Fire® Plus burner insert
- Matching composite burner cover included
- Access door conceals standard 20 lb. propane tank in base
- 55,000 BTUs

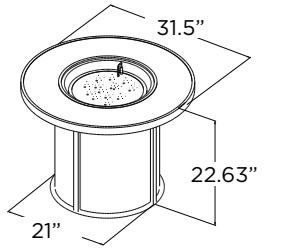

HVGG-1224-K

### Grey Havenwood

- Driftwood or Stone Grey Everblend™ concrete top
- Grey powder-coated metal base
- 12" x 24" Crystal Fire® Plus burner
- Grey glass burner cover included
- Access door conceals standard 20 lb. propane tank in base
- 55,000 BTUs
- Made in USA with US and imported parts

**Top options available**

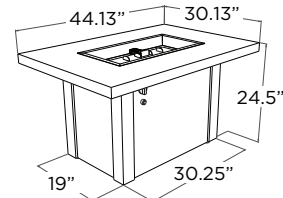

SF-32-GRY-K

### Grey Stonefire

- Grey composite top
- Grey powder-coated aluminum frame with grey mesh base
- 16" Crystal Fire® Plus burner insert
- Matching composite burner cover included
- Access door conceals standard 20 lb. propane tank in base
- 55,000 BTUs

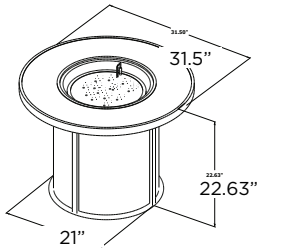

HVDW-1224-K with optional GLASS GUARD-1224

### White Havenwood

- Stone Grey or Driftwood Everblend™ concrete top
- White powder-coated metal base
- 12" x 24" Crystal Fire® Plus burner
- Grey glass burner cover included
- Access door conceals standard 20 lb. propane tank in base
- 55,000 BTUs
- Made in USA with US and imported parts

**Top options available**

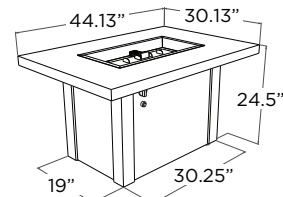
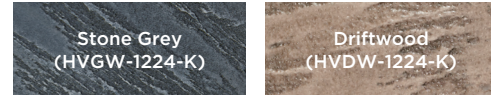

ED-20 with optional GLASS GUARD-20-R

### Edison

- Grey Barnwood Supercast™ concrete top
- Pewter Crater powder-coated metal base
- 20" Crystal Fire® Plus burner
- Matching Supercast concrete burner cover included
- Sliding access door conceals standard 20 lb. propane tank in base
- 55,000 BTUs
- Made in USA with US and imported parts

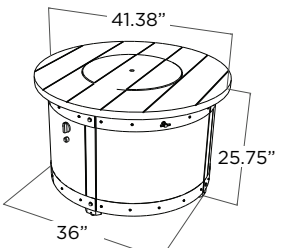

BC-20-MNB with optional GLASS GUARD-20-R

### Marbleized Noche Beacon

- Marbleized Noche Supercast™ concrete top
- Brown powder-coated metal base
- 20" Crystal Fire® Plus burner
- Matching Supercast burner cover included
- Sliding access door conceals standard 20 lb. propane tank in base
- 55,000 BTUs
- Made in USA with US and imported parts

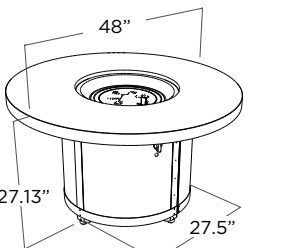

BC-20-WO

### White Onyx Beacon

- White Onyx Supercast™ concrete top
- Grey powder-coated metal base
- 20" Crystal Fire® Plus burner
- Matching Supercast burner cover included
- Sliding access door conceals standard 20 lb. propane tank in base
- 55,000 BTUs
- Made in USA with US and imported parts

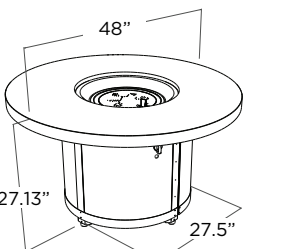

Looking for something more custom?

You dream it, we build it.

More on page 34.



BRON52-K with optional BRON52-CG-TC

### Bronson Round Kit

- Build-your-own gas fire pit kit
- 28" Crystal Fire® Plus burner insert inside 42" round plate
- Includes pavers (84), control panel, 2 vent blocks, and tumbled lava rock (72 lbs.)
- Does not fit 20 lb. LP tank in base
- 105,000/106,000 BTUs (LP/NG)
- Made in USA with US and imported parts

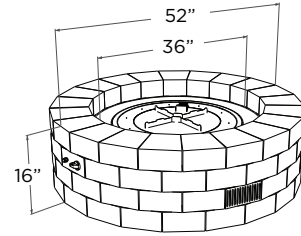

CV-20

### Cove 29"

- Natural Grey Supercast™ concrete base
- 20" Crystal Fire® Plus burner
- Grey glass burner cover included
- Does not fit 20 lb. LP tank in base
- 55,000 BTUs
- Made in USA with US and imported parts

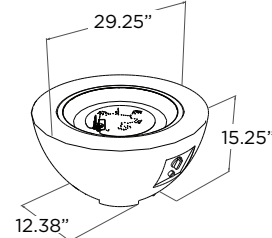

CV-30WT

### Cove 42"

- White, Midnight Mist, or Natural Grey Supercast™ concrete base
- 30" Crystal Fire® Plus burner
- Grey glass burner cover included
- Does not fit 20 lb. LP tank in base
- 105,000/106,000 BTUs (LP/NG)
- Made in USA with US and imported parts

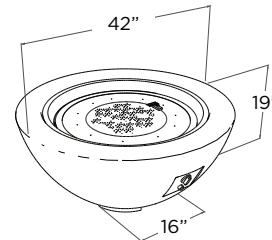

**Color options available**

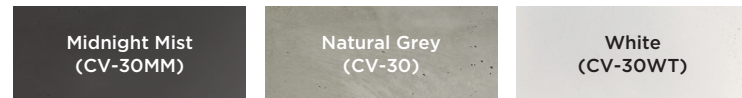

CV-30EMM

### Cove Edge 42"

- Midnight Mist, White, or Natural Grey Supercast™ concrete base
- 28" Crystal Fire® Plus burner insert inside round plate
- Does not include burner cover
- Does not fit 20 lb. LP tank in base
- 105,000/106,000 BTUs (LP/NG)
- Made in USA with US and imported parts

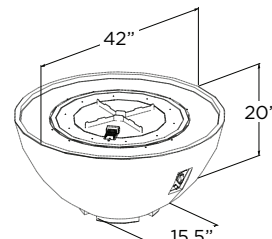

**Color options available**

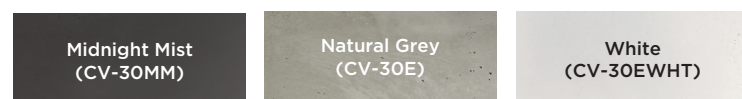

BRON5151-K

### Bronson Square Kit

- Build-your-own gas fire pit kit
- 28" Crystal Fire® Plus burner insert inside 42" square plate
- Includes pavers (64), control panel, 2 vent blocks, and tumbled lava rock (78 lbs.)
- Does not fit 20 lb. LP tank in base
- 105,000/106,000 BTUs (LP/NG)
- Made in USA with US and imported parts

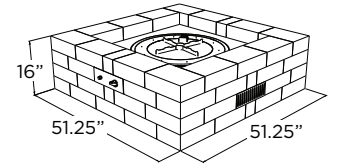

CV-2424 with optional GLASS GUARD-2424

### Cove Square

- Natural Grey Supercast™ concrete base
- 24" x 24" Crystal Fire® Plus burner
- Grey glass burner cover included
- Access door conceals standard 20 lb. propane tank in base
- 55,000 BTUs
- Made in USA with US and imported parts

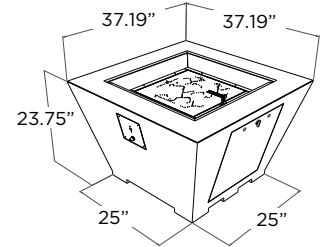

SIERRA-2424-M-K

### Sierra

- Mocha Supercast™ concrete top
- Faux stacked stone base
- 24" x 24" Crystal Fire® Plus burner
- Matching Supercast concrete burner cover included
- Sliding access door conceals standard 20 lb. propane tank in base
- 55,000 BTUs
- Made in USA with US and imported parts

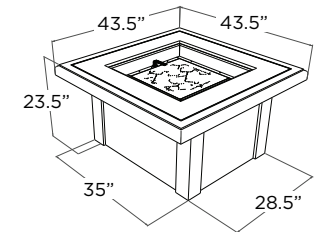

Stylize your outdoor room.





Design your own fire pit and fireplace.  
We supply the structure, and you finish your masterpiece on-site  
to match your landscaping or exterior design.

| READY-TO-FINISH





# Ready-to-Finish Fire Pit Kits

Be the visionary for your very own fire pit design.  
Ready-to-finish fire pit kits are made from Fiberock® backerboard and G90 steel framing.



Finished Linear Kit

- Made of G90 marine-grade galvanized steel framing and Fiberock® backerboard
  - Choose between manual ignition (VCSV) or direct spark ignition (DSI)
  - Includes aluminum top, burner insert, two ventilation plates, and standard control panel
  - Control panel will either have turn dial or switch depending on ignition type
  - Other DSI controls, timers, e-stops, and fire media sold separately
  - Recommended for hard piped natural gas or liquid propane installation
  - **Custom sizing available** — contact OGC for more information
  - Most do not fit 20 lb. liquid propane tank in base
  - Made in USA with US and imported parts
- See page 36 for custom capabilities.



Square kit with included components.

## Linear Kits

NAME	SKU (LP/NG)	BURNER INCLUDED	BTUs (LP/NG)	LENGTH	WIDTH	HEIGHT
<b>MANUAL IGNITION (VCSV)**</b>						
48" x 36" Linear Ready-to-Finish Kit	RTF48L-K	BI737	65,000/80,000	48"	36"	18"
48" x 36" Tall Linear Ready-to-Finish Kit*	RTF48TL-K	BI737	65,000/80,000	48"	36"	21"
60" x 36" Linear Ready-to-Finish Kit	RTF60L-K	BI737	65,000/80,000	60"	36"	18"
60" x 36" Tall Linear Ready-to-Finish	RTF60TL-K	BI737	65,000/80,000	60"	36"	21"
72" x 36" Linear Ready-to-Finish Kit	RTF72L-K	BI757	100,000	72"	36"	18"

### DIRECT SPARK IGNITION (DSI)\*\*

48" x 36" Linear Ready-to-Finish Kit	RTF48LDNG-K***	BI737DSING	65,000/80,000	48"	36"	18"
48" x 36" Tall Linear Ready-to-Finish Kit*	RTF48TLDLP-K/ RTF48TLDNG-K	BI737DSILP/ BI737DSING	65,000/80,000	48"	36"	21"
60" x 36" Linear Ready-to-Finish Kit	RTF60LDNG-K***	BI737DSING	65,000/80,000	60"	36"	18"
60" x 36" Tall Linear Ready-to-Finish	RTF60TLDLP-K/ RTF60TLDNG-K	BI737DSILP/ BI737DSING	65,000/80,000	60"	36"	21"
72" x 36" Linear Ready-to-Finish Kit	RTF72LDNG-K***	BI757DSING	100,000	72"	36"	18"

## Round Kits

NAME	SKU	BURNER INCLUDED	BTUs (LP/NG)	LENGTH	WIDTH	HEIGHT
<b>MANUAL IGNITION (VCSV)**</b>						
48" Round Ready-to-Finish Kit	RTF48C-K	BI28	105,000/106,000	48"	48"	18"
<b>DIRECT SPARK IGNITION (DSI)**</b>						
48" Round Ready-to-Finish Kit	RTF48CDNG-K***	BI28DSING	150,000	48"	48"	18"
60" Round Ready-to-Finish Kit	RTF60CDNG-K***	BI28DSING	150,000	60"	60"	18"

## Square Kits

NAME	SKU	BURNER INCLUDED	BTUs (LP/NG)	LENGTH	WIDTH	HEIGHT
<b>MANUAL IGNITION (VCSV)**</b>						
48" x 48" Square Ready-to-Finish Kit	RTF48S-K	BI28	105,000/106,000	48"	48"	18"
<b>DIRECT SPARK IGNITION (DSI)**</b>						
48" x 48" Square Ready-to-Finish Kit	RTF48SDNG-K***	BI28DSING	150,000	48"	48"	18"
60" x 60" Square Ready-to-Finish Kit	RTF60SDNG-K***	BI28DSING	150,000	60"	60"	18"

\*Fits 20 lb. liquid propane tank in base.

\*\*See page 42 for more information on manual ignition and page 50 for electronic ignition.

\*\*\*Liquid propane option available upon request.



# Ready-to-Finish Fireplaces

Perfect for both commercial and residential applications.  
Ready-to-finish fireplaces are made from Fiberock® backerboard and G90 steel framing.



Finished Custom RSTL-60DNG



Finished RFLP-40MLP

- Made of G90 marine-grade galvanized steel framing and Fiberock® backerboard
- Fireplace opening enclosure is lined with #304 stainless steel
- Most models include direct spark ignition (DSI) — 40" model utilizes manual ignition (VCSV) and includes access door for standard 20 lb. propane tank
- Includes Crystal Fire® Plus burner insert, pre-installed vents, standard control panel, and glass wind guard panel(s)
- Other DSI controls, timers, e-stops, and fire media sold separately
- Can be used for liquid propane or natural gas installations — hard-pipe natural gas installation recommended
- **Custom sizing available** — contact OGC for more information
- Made in USA with US and imported parts

See page 23 for fire media options and page 65 for custom form.



RSTL-60DLP



RFLP-40DLP

## See-Through Fireplaces

NAME	SKU	BURNER INCLUDED	BTUs (LP/NG)	OVERALL DIMENSIONS			VIEWING AREA	
				LENGTH	WIDTH	HEIGHT	LENGTH	HEIGHT
<b>MANUAL IGNITION (VCSV)*</b>								
40" See-Through Ready-to-Finish Fireplace*	RSTL-40MLP	BI737	65,000/ 80,000	73.5"	18.5"	48"	40"	20"
<b>DIRECT SPARK IGNITION (DSI)**</b>								
40" See-Through Ready-to-Finish Fireplace	RSTL-40DLP/ RSTL-40DNG	BI737DSILP/ BI737DSING	65,000/ 80,000	73.5"	18.5"	48"	40"	20"
60" See-Through Ready-to-Finish Fireplace	RSTL-60DLP/ RSTL-60DNG	BI757DSILP/ BI757DSING	100,000	92"	18.5"	48"	60"	20"
72" See-Through Ready-to-Finish Fireplace	RSTL-72DLP/ RSTL-72DNG	BI766DSILP/ BI766DSING	100,000	108"	18.5"	48"	72"	20"

## Single-Sided Fireplaces

NAME	SKU (LP/NG)	BURNER INCLUDED	BTUs (LP/NG)	OVERALL DIMENSIONS			VIEWING AREA	
				LENGTH	WIDTH	HEIGHT	LENGTH	HEIGHT
<b>MANUAL IGNITION (VCSV)*</b>								
40" Single-Sided Ready-to-Finish Fireplace*	RFLP-40MLP	BI737	65,000/ 80,000	73.5"	18.5"	48"	40"	20"
<b>DIRECT SPARK IGNITION (DSI)**</b>								
40" Single-Sided Ready-to-Finish Fireplace	RFLP-40DLP/ RFLP-40DNG	BI737DSILP/ BI737DSING	65,000/ 80,000	73.5"	18.5"	48"	40"	20"
60" Single-Sided Ready-to-Finish Fireplace	RFLP-60DLP/ RFLP-60DNG	BI757DSILP/ BI757DSING	100,000	92"	18.5"	48"	60"	20"
72" Single-Sided Ready-to-Finish Fireplace	RFLP-72DLP/ RFLP-72DNG	BI766DSILP/ BI766DSING	100,000	108"	18.5"	48"	72"	20"

## DSI Controls\*\*\*



4HRTC



4HRTE-CP



WSEP-CP



CFP-ESO-CP



DSI-SA

\*Manual ignition control panel is mounted on lower front face of fireplace. Includes NG conversion kit and access door for LP storage.

\*\*See page 42 for more information on manual ignition and page 50 for electronic ignition.

\*\*\*See page 54 for more information on electronic ignition controls.



Complete your outdoor fire feature with its own signature look.  
Our accessories provide a safe and durable complement to your fire.  
Easily customize your table with a glass wind guard, glass media, cover, and more.



| ACCESSORIES



# Accessories



## Fire Media

Tempered fire glass lights up the fire pit table with an ember-like glow. Complete your gas fire pit table or outdoor fireplace with beautiful tempered glass gems or lava rock. Choose from many shapes, sizes, and colors to create a custom look — you can even mix and match!

- Find your favorite for a unique, custom look
- Seven glass media gems to choose from
- Black lava rock, tumbled lava rock (2 different sizes), and ceramic log set favor a more natural look
- Realistic-looking ceramic log set includes six wood pieces
- Clear tempered glass gems (CFG-D) included with all fire pit tables

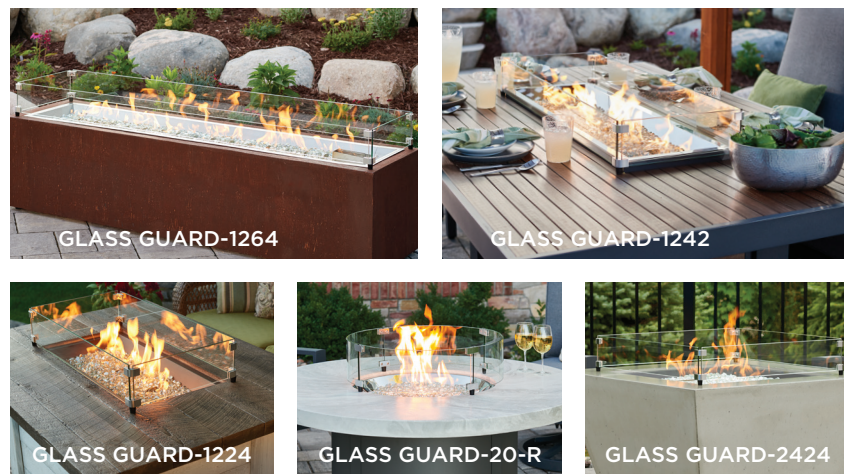

## Glass Wind Guards

Glass wind guards look beautiful with the reflection of the dancing flames. Glass guards are available to fit any standard Crystal Fire® Plus burner.

- Reduces wind effect and provides a safety barrier for children and animals
- Tempered glass panels
- Stainless steel hardware — round glass wind guards feature a stainless steel rod for added durability
- Easy to set up and clean

See page 66 for custom glass wind guard form.



## Folding Wind Guards

The convenience of a glass wind guard and burner cover in one. Place the panels of glass up to protect the flame from the wind, and place them down to cover your burner when not in use. Available in two sizes: 12" x 24" (FWG-1224) and 12" x 42" (FWG-1242). Patent pending.

- Sits on top of burner trim
- Clear tempered glass
- Stainless steel hardware
- Easy to set up and clean

See pages 58–61 for accessory glossary.



1224-GREY-GLASS-COVER



20-R-GGC



Matching Supercast™ Cover

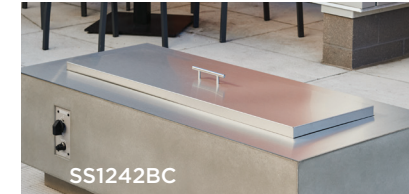

SS1242BC



CFT-GLASS



LAZY SUSAN RING

## Burner Covers

Turn your beautiful fire pit into a functional table by covering the burner with one of our stylish burner covers. Covers also add an extra layer of protection from rain and debris when not in use.

- Grey glass burner covers are included with most fire pit tables; available for all burner sizes
- Select Supercast™ tables come with matching Supercast burner covers
- Add a stainless steel burner cover to CV-54, CV-72, or other select linear models
- Add a lazy susan ring or black glass cover to any of our 20" round burner covers

See page 66 for custom burner cover form.



CVR5132

## Protective Covers

Protect your investment with protective covers from OGC! Protective covers are great for storing items long term or for everyday use.

- Available for most fire pit tables
- Tan polyester fabric stays cool to the touch
- Tear-resistant, rip-stop laminating
- Drawstring cord at bottom to secure to fire pit
- Polyester velvet interior protects finished material
- One-way breathability: exterior is water-resistant while being one-way breathable to let any interior moisture out



CV-54 with optional SS54T

## Stainless Steel Trim

Compliment the unique look of the 54" and 72" Cove Linear tables (CV-54, CV-72) with this modern stainless steel top.

- Available in two sizes: 54" (SS54T) and 72" (SS72T)
- #304 commercial-grade stainless steel construction
- Adds layer of protection to concrete surface
- Easy to clean



BRON52-K with optional BRON52-CG-TC

## Bronson Concrete Tops

Complete your Bronson round gas fire pit kit with an elegant, contemporary concrete top.

- Choose between two colors: Limestone Tan (BRON52-LT-TC) or Charcoal Grey (BRON52-CG-TC)
- Four pieces included with each SKU

### Color options available

Limestone Tan (BRON52-LT-TC)

Charcoal Grey (BRON52-CG-TC)



Comfortable furniture makes any outdoor room complete. Whether you have a modern or traditional backyard style, we've got just the right chair for you. Choose between a variety of designs and sizes to find the perfect addition to your outdoor space.



| OUTDOOR FURNITURE



# Outdoor Furniture



DAR-CH (table not included)

## Darien Chairs

- Grey powder-coated aluminum frame with Grade A teak accents
- Cushions provide deep, comfy seating
- Grey outdoor-rated Olefin fabric
- Pair with Darien gas fire pit tables (DAR-1224-K or DAR-1224-EBG-K)
- Set of 2

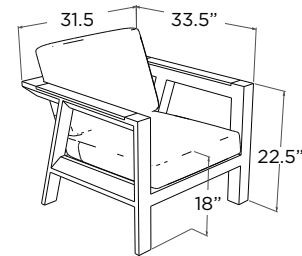

EMPIRE-BAR (table not included)

## Empire Bar Stools

- Taupe outdoor-rated fabric with padded sling
- Dora brown powder-coated aluminum frame
- Perfect height for pub tables and outdoor kitchens
- Swivel bar stool
- Set of 2

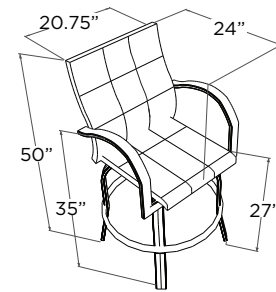

NAPLES-4030-L (table not included)

## Naples Bar Stools

- Leather brown outdoor resin wicker
- Dora brown powder-coated aluminum frame
- Perfect height for pub tables and outdoor kitchens
- Swivel bar stool
- Set of 2

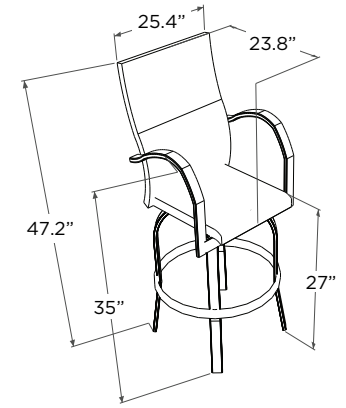

KW-LB and KW-SB

## Kenwood Benches

- Umber brown composite decking
- Grey powder-coated aluminum frame
- Pair with Kenwood gas fire pit tables (KW-1224-19-K or KW-1242-K)
- Benches sold individually

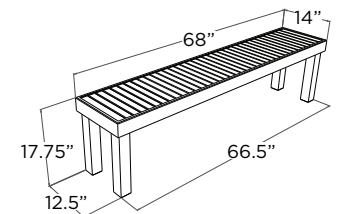
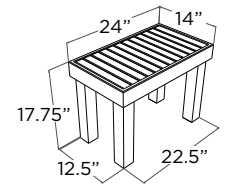

Complete your Outdoor Room.



## Intrigue Outdoor Lantern

Turn your dining table into the wow factor of your backyard. Our innovative, spinning Venturi flame provides instant ambiance for your outdoor space. The Intrigue Outdoor Lantern is clean burning, easy to use, and fits any outdoor design.



INT-EZ

- Spinning Venturi flame designed to fit any table with an umbrella hole from 1.4"-4"
- Dora brown powder-coated finish
- Easy to assemble
- Single glass cylinder
- Use with 1 lb. propane tank
- For outdoor use only
- Includes black rubber glass lid
- Optional cover (CVRINT) sold separately
- UL and ULC listed

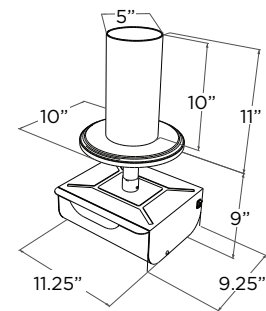





CUSTOM CAPABILITIES



## Custom Finishes

Create a masterpiece that's unique to your living area.  
We help you along this exciting journey with our distinctive custom creation process.  
Our materials and construction methods are designed to last. Actual finish colors may vary.



Midnight Mist and Black Fleck on KL-1242-MM



Washed Cedar on CR-1242-K



Marbleized Noche and Dora Brown on BC-20-MNB

### Supercast™ Concrete

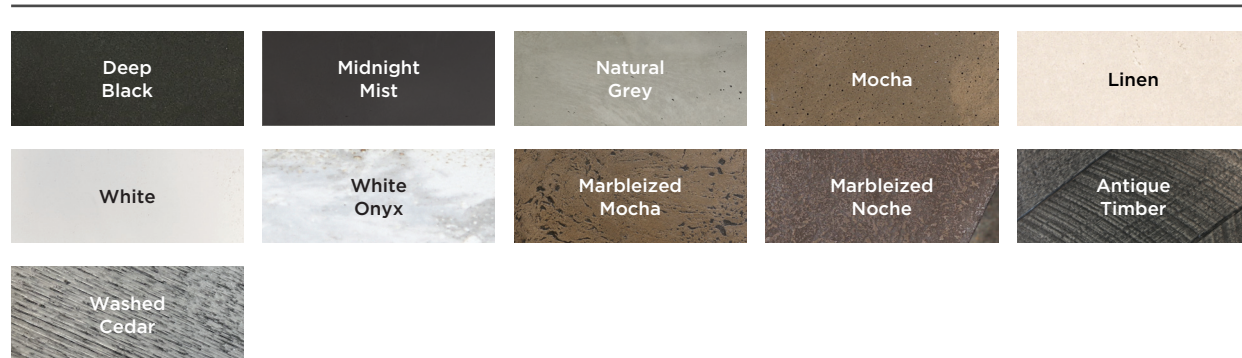

### Stucco

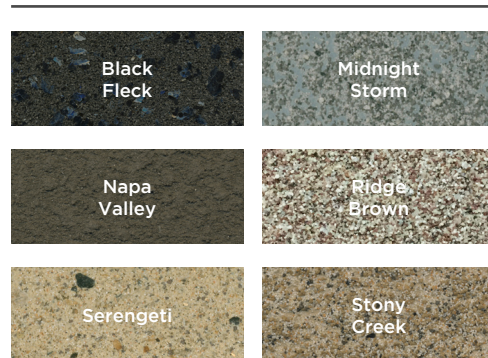

### Metal

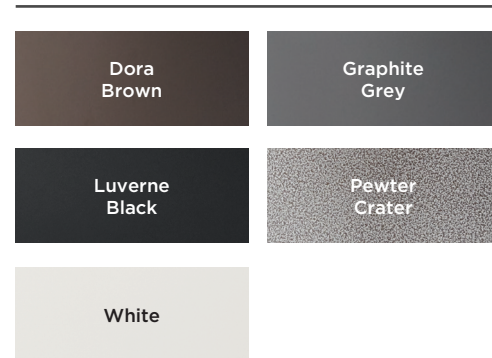

## Custom Finishes Chart

### Supercast™ Concrete

NAME	COVE FIRE PITS	FIRE TABLE TOP	KITCHEN TOP
Deep Black	X	X	X
Natural Grey	X	X	X
Midnight Mist	X	X	X
White	X	X	X
White Onyx		X	X
Linen	X	X	X
Mocha	X	X	X
Marbleized Mocha		X	X
Marbleized Noche		X	X
Antique Timber	Request for quote.	X	X
Washed Cedar	Request for quote.	X	X

### Stucco

NAME	FIRE TABLE BASE	KITCHEN BASE
Black Fleck	X	X
Midnight Storm	X	X
Napa Valley	X	X
Ridge Brown	X	X
Serengeti	X	X
Stony Creek	X	X

### Metal

NAME	FIRE TABLE BASE	KITCHEN BASE
Dora Brown	X	X
Graphite Grey	X	X
Luverne Black	X	X
Pewter Crater	X	X
White	X	X



## Custom Fire

Ignite your outdoor living area with a custom fire feature.  
We'll work with you on making your dream design come to life.  
Perfect for residential, commercial, or multi-family properties.

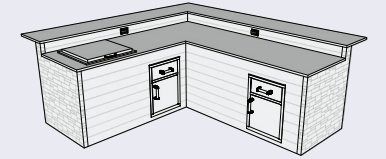
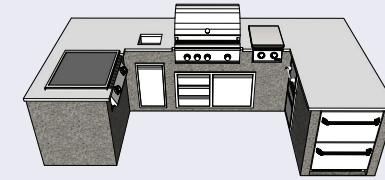
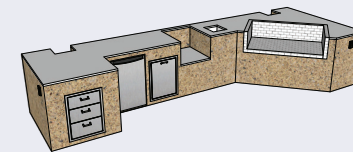
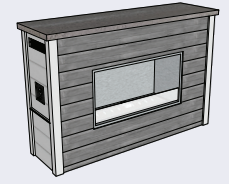
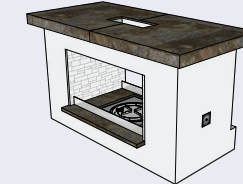
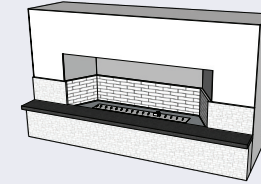
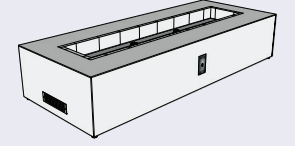
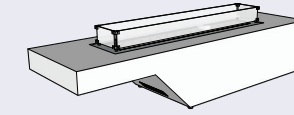
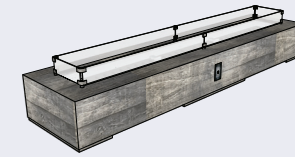

### Our Custom Process

With our Minnesota-based customer service, design, engineering, and manufacturing abilities, we can help you design, build, and deliver the custom project you've been dreaming of. The process is simple and includes five steps to ensure we do everything correctly.

- 1 Start with something as basic as a sketch, desired dimensions, or material change to one of the many items in our catalog.
- 2 Use our custom request form and fill it out as completely as possible. See pages 63-66 for custom request forms.
- 3 The Outdoor GreatRoom Company will provide an estimate for the project.
- 4 A custom rendering will be created (examples above) and submitted to you for approval.
- 5 Once everything is approved, a signed drawing and corresponding purchase order is submitted to OGC to start the creation process.

- Customize many of our standard fire pit tables or create your own unique gas fire pit or outdoor fireplace
  - Common materials used are Supercast™ concrete, stucco, metal, tile, and stacked stone (see page 35 for available finishes.)
  - Size and shape to fit your design
  - Specify desired accessories, fuel type, and other notes in the custom form
  - Other upgrades may include LED underlighting, custom glass guards, custom burner covers, and more
  - UL and ULC listed Crystal Fire® Plus burners
  - Made in USA with US and imported parts
- See pages 63 and 65 for custom request forms.



# Custom Outdoor Kitchens

Turn your outdoor dream into a practical reality.  
Create your own custom outdoor kitchen and compliment it with your desired outdoor appliances.  
Choose between a variety of outdoor-rated materials or finish it on your own to match your exterior design.



21SINGL-V



28SINGL-H



25DAD/32DAD



32DDDC



30DRW1



16DRW2



16DRW3



30ICEINS



16PTH



20TRO



32DRYSTO



25ICEBIN



DAR044A5BSLDD



SINK

## Optional Kitchen Accessories

NAME	SKU	LENGTH	WIDTH	HEIGHT
21" Vertical Single Access Door	21SINGL-V	17.25"	N/A	24.25"
Horizontal Single Access Door	28SINGL-H	24.25"	N/A	17.25"
25" Double Access Door	25DAD	21.38"	N/A	18.25"
32" Double Access Door	32DAD	28.38"	N/A	18.25"
32" Access Door and Double Drawer Combo	32DDDC	30.13"	21"	19.13"
30" Single Drawer	30DRW1	28.25"	21"	13.25"
16" Double Drawer	16DRW2	15.38"	21"	19.63"
16" Triple Drawer	16DRW3	15.38"	21"	27.63"
30" Roll Out Insulated Ice Drawer	30ICEINS	26.25"	21"	19.75"
16" Paper Towel Holder	16PTH	14.13"	8.63"	8.63"
20" Roll Out Trash or Propane Tank Drawer	20TRO	17.88"	16.38"	24.25"
32" Double Access Door Sealed Dry Storage	32DRYSTO	30.25"	21"	19.25"
25" Drop In Ice Bin Cooler with Condiment Tray	25ICEBIN	23.75"	23.75"	11.75"
Danby Refrigerator with Stainless Steel Door and Glass Shelves	DAR044A5BSLDD	21.25"	21"	33.5"
#304 Stainless Steel Sink with Single Faucet	SINK	14.5"	14.5"	6" below; 9" above

- Custom kitchens utilize G90 marine grade galvanized steel framing with Fiberock® backerboard
- Common materials used are Supercast™ concrete, stucco, metal, tile, and stacked stone (see page 35 for available finishes)
- Customize your design to include a backsplash, elevated bar, Crystal Fire® Plus gas burner, storage, your favorite grills or other appliances, and more!
- Made in USA with US and imported parts

See page 64 for custom request form.



Crystal Fire® Plus burners are included with every gas fire pit table sold by The Outdoor GreatRoom Company. Purchase separately for custom-built fire pits, fireplaces, or other outdoor installations.



**Crystal Fire** <sup>PLUS</sup>   
**| BURNERS & KITS**



# Crystal Fire® Plus Burners



**Overmount Style**  
(burner shown: CFP1242-K with optional GLASS GUARD-1242)



**Undermount Style**  
(burner shown: BP1264-A)



- Burners and burner kits include a variable control safety valve (VCSV), control panel, and clear tempered fire glass gems
- Higher BTU capacity for a brighter, taller, fuller, more yellow flame
- Safety ignition and safety shutdown operations
- “Positive connect” user experience with minimal gas connections for quick installation time
- #304 commercial-grade stainless steel construction
- Safe water drain system through perimeter of the pan
- Comes setup for connection to liquid propane but can be field-converted to natural gas
- Burners and kits above 64” in length include two valves and two control panels
- Installation should be completed by a certified gas technician
- UL and ULC listed to ANSI Z.21.97-2017/CSA 2.41-2017 standard

See page 49 for contract and commercial burner options.



CFP1224-K

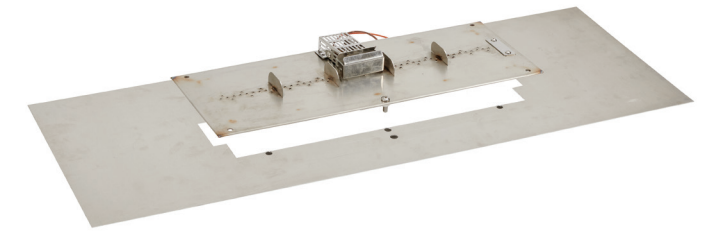

BP1236-A

## Linear Burners (overmount style)

NAME	SKU	BTUs (LP/NG)	LENGTH	WIDTH	HEIGHT	MAXIMUM FIRE MEDIA
12" x 24" Crystal Fire® Plus Burner	CFP1224-K	55,000*	25.63"	13.5"	4.81"	10 lbs
12" x 42" Crystal Fire® Plus Burner	CFP1242-K	65,000/ 80,000*	42.6"	13.5"	4.81"	15 lbs
12" x 64" Crystal Fire® Plus Burner	CFP1264	100,000	64.3"	13.5"	4.81"	20 lbs
12" x 72" Crystal Fire® Plus Burner	CFP1272	125,000	72"	13.5"	4.81"	25 lbs
12" x 84" Crystal Fire® Plus Burner	CFP1284	140,000	84"	13.5"	4.81"	25 lbs
12" x 96" Crystal Fire® Plus Burner	CFP1296	165,000	96"	13.5"	4.81"	30 lbs
12" x 108" Crystal Fire® Plus Burner	CFP12108	180,000	108"	13.5"	4.81"	35 lbs
12" x 120" Crystal Fire® Plus Burner	CFP12120	200,000	120"	13.5"	4.81"	40 lbs

## Linear Burner Insert and Plate Kits (undermount style)

NAME	SKU**	BTUs (LP/NG)	LENGTH	WIDTH	HEIGHT	MAXIMUM FIRE MEDIA
12" x 24" Crystal Fire® Plus Burner Insert and Plate Kit	BP1224-A	55,000*	25.63"	13.5"	4.29"	15 lbs
12" x 36" Crystal Fire® Plus Burner Insert and Plate Kit	BP1236-A	55,000*	36"	13.5"	4.29"	20 lbs
12" x 42" Crystal Fire® Plus Burner Insert and Plate Kit	BP1242-A	80,000*	42.6"	13.5"	4.29"	20 lbs
12" x 60" Crystal Fire® Plus Burner Insert and Plate Kit	BP1260-A	80,000*	60"	13.5"	4.29"	25 lbs
12" x 64" Crystal Fire® Plus Burner Insert and Plate Kit	BP1264-A	100,000	64.3"	13.5"	4.29"	25 lbs
12" x 72" Crystal Fire® Plus Burner Insert and Plate Kit	BP1272-A	125,000	72"	13.5"	4.29"	30 lbs
12" x 84" Crystal Fire® Plus Burner Insert and Plate Kit	BP1284-A	140,000	84"	13.5"	4.29"	30 lbs
12" x 96" Crystal Fire® Plus Burner Insert and Plate Kit	BP1296-A	165,000	96"	13.5"	4.29"	35 lbs
12" x 108" Crystal Fire® Plus Burner Insert and Plate Kit	BP12108-A	180,000	108"	13.5"	4.29"	40 lbs
12" x 120" Crystal Fire® Plus Burner Insert and Plate Kit	BP12120-A	200,000	120"	13.5"	4.29"	45 lbs

\*Booster orifice available to increase BTU capacity if desired and approved for finishing structure. Glass wind guard required if booster orifice used with any OGC gas fire pit table.

\*\*Burner plate kits include corresponding burner insert and burner plate. Burner insert can be purchased on its own if desired. Contact OGC for burner insert specifications.



**Overmount Style**  
(burner shown: CFP20-K)



**Undermount Style**  
(burner shown: BP30RD-A)



**Overmount Style**  
(burner shown: CFP2424-K)



**Undermount Style**  
(burner shown: BP42S-A)

### Round Burners (overmount style)

NAME	SKU	BTUs (LP/NG)	LENGTH	WIDTH	HEIGHT	FIRE MEDIA
20" Round Crystal Fire® Plus Burner	CFP20-K	55,000*	21.06"	21.06"	5.39"	10 lbs
30" Round Crystal Fire® Plus Burner	CFP30-K	105,000/ 106,000	32"	32"	5.39"	25 lbs

### Round Burner Insert and Plate Kits (undermount style)

NAME	SKU**	BTUs (LP/NG)	LENGTH	WIDTH	HEIGHT	FIRE MEDIA
20" Round Crystal Fire® Plus Burner Insert and Plate Kit	BP20RD-A	55,000*	21.06"	21.06"	4.82"	15 lbs
24" Round Crystal Fire® Plus Burner Insert and Plate Kit	BP24RD-A	55,000*	24"	24"	4.82"	20 lbs
30" Round Crystal Fire® Plus Burner Insert and Plate Kit	BP30RD-A	105,000/ 106,000	32"	32"	4.82"	25 lbs
36" Round Crystal Fire® Plus Burner Insert and Plate Kit	BP36RD-A	105,000/ 106,000	36"	36"	4.82"	50 lbs
42" Round Crystal Fire® Plus Burner Insert and Plate Kit	BP42RD-A	105,000/ 106,000	42"	42"	4.82"	70 lbs
48" Round Crystal Fire® Plus Burner Insert and Plate Kit	BP48RD-A	105,000/ 106,000	48"	48"	4.82"	90 lbs

\*Booster orifice available to increase BTU capacity if desired and approved for finishing structure. Glass wind guard required if booster orifice used with any OGC gas fire pit table.

\*\*Burner plate kits include corresponding burner insert and burner plate. Burner insert can be purchased on its own if desired. Contact OGC for burner insert specifications.

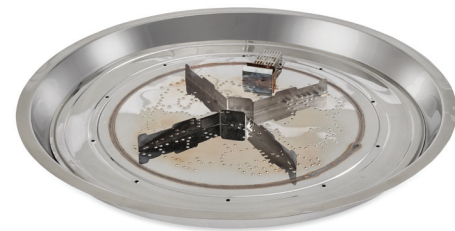

CFP30-K



BP36RD-A



CFP2424-K



BP36S-A

### Square Burners (overmount style)

NAME	SKU	BTUs (LP/NG)	LENGTH	WIDTH	HEIGHT	FIRE MEDIA
24" x 24" Crystal Fire® Plus Burner	CFP2424-K	55,000*	25.75"	25.75"	4.63"	20 lbs

### Square Burner Insert and Plate Kits (undermount style)

NAME	SKU**	BTUs (LP/NG)	LENGTH	WIDTH	HEIGHT	FIRE MEDIA
24" x 24" Crystal Fire® Plus Burner Insert and Plate Kit	BP24S-A	55,000*	24"	24"	4.2"	30 lbs
30" x 30" Crystal Fire® Plus Burner Insert and Plate Kit	BP30S-A	55,000*	30"	24"	4.2"	45 lbs
36" x 36" Crystal Fire® Plus Burner Insert and Plate Kit	BP36S-A	105,000/ 106,000	36"	36"	4.2"	65 lbs
42" x 42" Crystal Fire® Plus Burner Insert and Plate Kit	BP42S-A	105,000/ 106,000	42"	42"	4.2"	90 lbs

\*Booster orifice available to increase BTU capacity if desired and approved for finishing structure. Glass wind guard required if booster orifice used with any OGC gas fire pit table.

\*\*Burner plate kits include corresponding burner insert and burner plate. Burner insert can be purchased on its own if desired. Contact OGC for burner insert specifications.

## Controls



VCSV-CP



VCSV-DIY-CP

- If flame is not sensed for any reason, the flow of gas to the burner will safely shut down
- Adjustable flame operation
- Black powder-coated panel with black plastic knob and sparker
- For use with liquid propane or natural gas
- Optional gas key available
- Variable Control Safety Valve System (VCSV-CP) included with every standard table Crystal Fire® Plus burner and gas fire pit table (Dimensions: 6.375" H x 3.5" W)
- DIY control panel for use on custom or hardscape block applications (Dimensions: 9.5" L x 3" W x 4" H)
- Order DIY control panel for use with manual ignition (VCSV-DIY-CP) or direct spark ignition (DSI-DIY-CP)

## Ventilation



VENT BLOCK BLACK

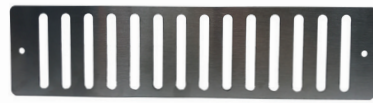

21005

- Crystal Fire® Plus burners require proper ventilation for any DIY or field-installed application
- Black ventilation block (VENT BLOCK BLACK) is made of black powder-coated stainless steel (Dimensions: 8.5" L x 4" W x 4" H)
- Ventilation plate (21005) is made of brushed stainless steel (Dimensions: 12" L x 3" W" x <1" H)



## Do-it-Yourself Kits

Take the guesswork out of your do-it-yourself project with these convenient burner kits. Each kit includes everything you need for building the perfect fire pit. Just add brick pavers or other construction materials to make it your own!



VENT BLOCK BLACK



VCSV-DIY-CP



CFG-D



BP36RD-A

## Get the complete kit with our Bronson Block collection.

### The ultimate DIY project.

See pages 14 and 15 for more information.

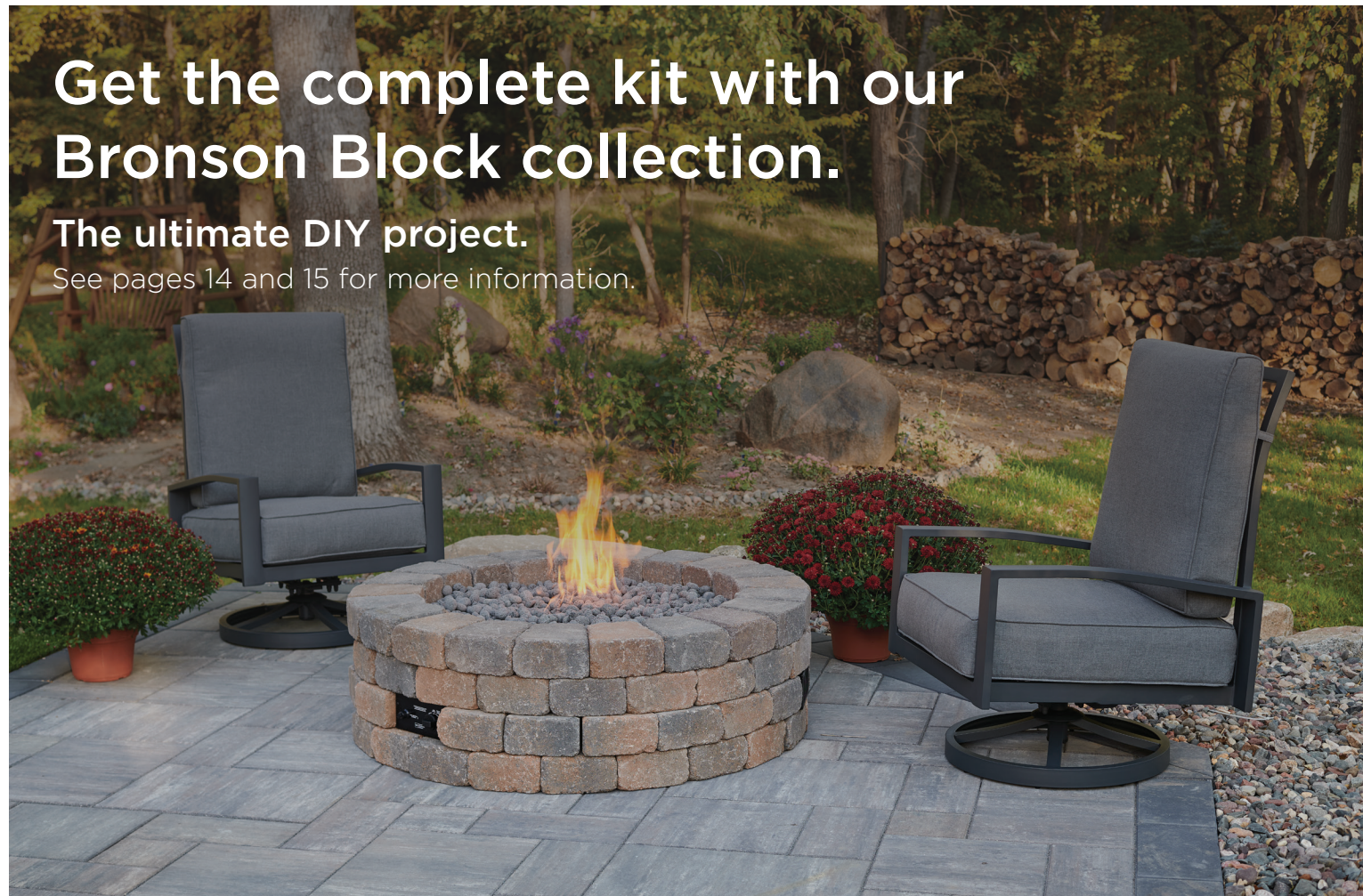

## Specifications

NAME	SKU	BURNER INCLUDED	BTUs (LP/NG)	INCLUDED CLEAR GLASS GEMS
<b>ROUND KITS</b>				
24" Round Do-it-Yourself Crystal Fire® Plus Burner Kit	DIY-24RD-K	BP24RD-A	55,000	24 lbs
36" Round Do-it-Yourself Crystal Fire® Plus Burner Kit	DIY-36RD-K	BP36RD-A	105,000/106,000	36 lbs
42" Round Do-it-Yourself Crystal Fire® Plus Burner Kit	DIY-42RD-K	BP42RD-A	105,000/106,000	60 lbs
48" Round Do-it-Yourself Crystal Fire® Plus Burner Kit	DIY-48RD-K	BP48RD-A	105,000/106,000	96 lbs
<b>SQUARE KITS</b>				
24" x 24" Do-it-Yourself Crystal Fire® Plus Burner Kit	DIY-2424S-K	BP24S-A	55,000	24 lbs
30" x 30" Do-it-Yourself Crystal Fire® Plus Burner Kit	DIY-3030S-K	BP30S-A	55,000	36 lbs
36" x 36" Do-it-Yourself Crystal Fire® Plus Burner Kit	DIY-3636S-K	BP36S-A	105,000/106,000	48 lbs
42" x 42" Do-it-Yourself Crystal Fire® Plus Burner Kit	DIY-4242S-K	BP42S-A	105,000/106,000	96 lbs

- Build your own gas fire pit with a do-it-yourself gas fire pit kit
- Includes Crystal Fire® Plus burner insert, burner plate, control panel, two ventilation blocks, and clear tempered glass gems
- Choose between round or square shapes
- Paver blocks not included
- Made in USA with US and imported parts





Perfect for multi-family residences, hotels, sporting arenas, concert venues, restaurants, and more. Any Outdoor GreatRoom Company product can be outfitted for contract and commercial spaces. All commercial burners include a control panel, emergency stop button, clear glass gems and electronic ignition.



**Crystal Fire** <sup>PLUS</sup>   
| CONTRACT & COMMERCIAL



# Contract and Commercial

## Overmount Styles



## Undermount Styles



- Direct spark ignition (DSI) system with on/off switch operation
- Flame can be automatically ignited with a single control either on the fire pit or nearby surface
- If flame is not sensed for any reason, the flow of gas to the burner will safely shut down
- DSI system comes set up to run on 110V but can also be used on optional battery operation (CF-DSI-BP)
- Order specific for liquid propane or natural gas (not field-convertible)
- Includes red emergency stop button
- Switch bypass (CF-DSI-SB) included with burner for safe and controlled user operation
- Optional timer, wall switch, Bluetooth® smart app, and other control panel configurations sold separately (see page 54 for control options)
- Ventilation required for field-installed burner enclosures
- Installation should be completed by a certified gas technician
- Patent pending
- UL and ULC listed

See page 41 for manual ignition (VCSV) burners.



Burner with included components.



CFP1224DSILP  
CFP1224DSING

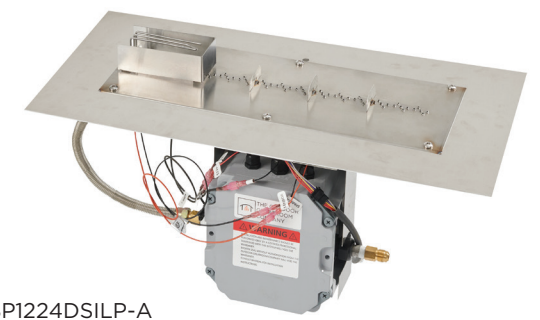

BP1224DSILP-A  
BP1224DSING-A

## Linear Burners (overmount style)

NAME	SKU (LP/NG)	BTUs (LP/NG)	LENGTH	WIDTH	HEIGHT	MAXIMUM FIRE MEDIA
12" x 24" Crystal Fire® Plus Burner with DSI	CFP1224DSILP/ CFP1224DSING	55,000**	25.63"	13.5"	14.39"	10 lbs
12" x 42" Crystal Fire® Plus Burner with DSI	CFP1242DSILP/ CFP1242DSING	65,000/ 80,000**	42.6"	13.5"	14.38"	15 lbs
12" x 64" Crystal Fire® Plus Burner with DSI	CFP1264DSING*	100,000	64.3"	13.5"	14.38"	20 lbs
12" x 72" Crystal Fire® Plus Burner with DSI	CFP1272DSING*	100,000	72"	13.5"	14.38"	25 lbs
12" x 84" Crystal Fire® Plus Burner with DSI	CFP1284DSING*	120,000	84"	13.5"	14.38"	25 lbs
12" x 96" Crystal Fire® Plus Burner with DSI	CFP1296DSING*	130,000	96"	13.5"	14.38"	30 lbs
12" x 108" Crystal Fire® Plus Burner with DSI	CFP12108DSING*	140,000	108"	13.5"	14.38"	35 lbs
12" x 120" Crystal Fire® Plus Burner with DSI	CFP12120DSING*	140,000	120"	13.5"	14.38"	40 lbs

## Linear Burner Insert and Plate Kits (undermount style)

NAME	SKU*** (LP/NG)	BTUs (LP/NG)	LENGTH	WIDTH	HEIGHT	MAXIMUM FIRE MEDIA
12" x 24" Crystal Fire® Plus Burner Insert and Plate Kit with DSI	BP1224DSILP-A/ BP1224DSING-A	55,000**	25.63"	13.5"	14.24"	15 lbs
12" x 36" Crystal Fire® Plus Burner Insert and Plate Kit with DSI	BP1236DSILP-A/ BP1236DSING-A	55,000**	36"	13.5"	14.24"	20 lbs
12" x 42" Crystal Fire® Plus Burner Insert and Plate Kit with DSI	BP1242DSILP-A/ BP1242DSING-A	80,000**	42.6"	13.5"	14.24"	20 lbs
12" x 60" Crystal Fire® Plus Burner Insert and Plate Kit with DSI	BP1260DSILP-A/ BP1260DSING-A	80,000**	60"	13.5"	14.24"	25 lbs
12" x 64" Crystal Fire® Plus Burner Insert and Plate Kit with DSI	BP1264DSING-A*	100,000	64.3"	13.5"	14.39"	25 lbs
12" x 72" Crystal Fire® Plus Burner Insert and Plate Kit with DSI	BP1272DSING-A*	100,000	72"	13.5"	14.26"	30 lbs
12" x 84" Crystal Fire® Plus Burner Insert and Plate Kit with DSI	BP1284DSING-A*	120,000	84"	13.5"	14.26"	30 lbs
12" x 96" Crystal Fire® Plus Burner Insert and Plate Kit with DSI	BP1296DSING-A*	130,000	96"	13.5"	14.26"	35 lbs
12" x 108" Crystal Fire® Plus Burner Insert and Plate Kit with DSI	BP12108DSING-A*	140,000	108"	13.5"	14.26"	40 lbs
12" x 120" Crystal Fire® Plus Burner Insert and Plate Kit with DSI	BP12120DSING-A*	140,000	120"	13.5"	14.26"	45 lbs

\*Liquid propane option available upon request.

\*\*Booster orifice available to increase BTU capacity if desired and approved for finishing structure. Glass wind guard required if booster orifice used with any OGC gas fire pit table.

\*\*\*Burner plate kits include corresponding burner insert and burner plate. Burner insert can be purchased on its own if desired. Contact OGC for burner insert specifications.



Add some flare to your space.

### Round Burners (overmount style)

NAME	SKU (LP/NG)	BTUs (LP/NG)	LENGTH	WIDTH	HEIGHT	MAXIMUM FIRE MEDIA
20" Round Crystal Fire® Plus Burner with DSI	CFP20DSILP/ CFP20DSING	55,000*	21.06"	21.06"	11.71"	10 lbs
30" Round Crystal Fire® Plus Burner with DSI	CFP30DSILP/ CFP30DSING	150,000	32"	32"	11.2"	25 lbs

### Round Burner Insert and Plate Kits (undermount style)

NAME	SKU** (LP/NG)	BTUs (LP/NG)	LENGTH	WIDTH	HEIGHT	MAXIMUM FIRE MEDIA
20" Round Crystal Fire® Plus Burner Insert & Plate Kit with DSI	BP20RDDSILP-A/ BP20RDDSING-A	55,000*	21.06 "	21.06 "	15.3"	15 lbs
24" Round Crystal Fire® Plus Burner Insert & Plate Kit with DSI	BP24RDDSILP-A/ BP24RDDSING-A	55,000*	24"	24"	15.3"	20 lbs
30" Round Crystal Fire® Plus Burner Insert & Plate Kit with DSI	BP30RDDSILP-A/ BP30RDDSING-A	150,000	32"	32"	14.61"	25 lbs
36" Round Crystal Fire® Plus Burner Insert & Plate Kit with DSI	BP36RDDSILP-A/ BP36RDDSING-A	150,000	36"	36"	14.61"	50 lbs
42" Round Crystal Fire® Plus Burner Insert & Plate Kit with DSI	BP42RDDSILP-A/ BP42RDDSING-A	150,000	42"	42"	14.61"	70 lbs
48" Round Crystal Fire® Plus Burner Insert & Plate Kit with DSI	BP48RDDSILP-A/ BP48RDDSING-A	150,000	48"	48"	14.61"	90 lbs

\*Booster orifice available to increase BTU capacity if desired and approved for finishing structure. Glass wind guard required if booster orifice used with any OGC gas fire pit table.

\*\*Burner plate kits include corresponding burner insert and burner plate. Burner insert can be purchased on its own if desired. Contact OGC for burner insert specifications.



CFP30DSILP  
CFP30DSING



BP36RDDSILP-A  
BP36RDDSING-A



CFP2424DSILP  
CFP2424DSING



BP36SDSILP-A  
BP36SDSING-A

### Square Burners (overmount style)

NAME	SKU (LP/NG)	BTUs (LP/NG)	LENGTH	WIDTH	HEIGHT	MAXIMUM FIRE MEDIA
24" x 24" Crystal Fire® Plus Burner with DSI	CFP2424DSILP/ CFP2424DSING	55,000*	25.75"	25.75"	14.71"	20 lbs

### Square Burner Insert and Plate Kits (undermount style)

NAME	SKU** (LP/NG)	BTUs (LP/NG)	LENGTH	WIDTH	HEIGHT	MAXIMUM FIRE MEDIA
24" x 24" Crystal Fire® Plus Burner Insert & Plate Kit with DSI	BP24SDSILP-A/ BP24SDSING-A	55,000*	24"	24"	14.66"	30 lbs
30" x 30" Crystal Fire® Plus Burner Insert & Plate Kit with DSI	BP30SDSILP-A/ BP30SDSING-A	55,000*	30"	30"	14.66"	45 lbs
36" x 36" Crystal Fire® Plus Burner Insert & Plate Kit with DSI	BP36SDSILP-A/ BP36SDSING-A	150,000	36"	36"	14.66"	65 lbs
42" x 42" Crystal Fire® Plus Burner Insert & Plate Kit with DSI	BP42SDSILP-A/ BP42SDSING-A	150,000	42"	42"	14.66"	90 lbs

\*Booster orifice available to increase BTU capacity if desired and approved for finishing structure. Glass wind guard required if booster orifice used with any OGC gas fire pit table.

\*\*Burner plate kits include corresponding burner insert and burner plate. Burner insert can be purchased on its own if desired. Contact OGC for burner insert specifications.

## Factors to consider when selecting your burner:

- 1 **Installation Site:** Is your burner going into an already built surround or will you need a fire table or ready-to-finish base for your burner?
- 2 **Burner Mount:** Whether you are looking for a top overmount or bottom undermount application, we have the burner for you. Choose from drop in burners or burner insert and plate kits.
- 3 **Installation Opening:** What size and shape is your installation opening? Choose from our stocked burners or burner insert and plate kits to fit your space. If a stocked option is not available, ask about our custom options.
- 4 **Operation and Controls:** Do you want controls available for public use or in a more secure, controlled setting? Choose controls, such as a timer, Bluetooth® application, or on/off switch for your application.

## Timers



4HRTC



CF-DSI-60MT

- Available in 1-hour and 4-hour options
- Timer replaces controls for direct spark ignition system
- Timer is built into control panel
- Black powder-coated panel with white timer dial
- Dimensions: 6.375" L x 3.5" W

## Emergency Stop Button



CFP-ESO-CP



- Immediately shuts off flame when pressed
- Red button included with direct spark ignition system
- Black powder-coated panel with red plastic emergency stop button
- Dimensions: 4.5" L x 2.625" W

## On/Off Switch with Emergency Stop Button



WSEP-CP



- On/Off wall switch with emergency stop button
- Replaces controls for direct spark ignition system
- For applications away from the appliance
- Black powder-coated panel with black switch
- Dimensions: 4.5" L x 4.525" W

## Timer with Emergency Stop Button



4HRTES-CP



- Four-hour timer with emergency stop button
- Replaces controls for direct spark ignition system
- For applications away from the appliance
- Black powder-coated panel with white timer dial
- Dimensions: 4.5" L x 4.625" W

## Bluetooth® Smart App

- Ignite your fire pit or fireplace from your smart device
- Convenient timer automatically turns off the fire
- User-friendly application offers easy installation and syncing process
- Syncs over Bluetooth®
- Available for use with all direct spark ignition systems
- Compatible with iOS™ and Android™
- For residential use only



DSI-SA



# Black Wave Gas Burner

Modern meets innovation with this unique burner design!  
The Wave can be installed in custom-built gas fire pits, fireplaces, or other outdoor projects.  
The three-tube burner is made from high-quality, black powder-coated stainless steel.



WV-56-LP  
WV-56-NG

- Black powder-coated #304 stainless steel
- 54" three-tube burner with black onyx tempered fire glass gems - 150,000 BTUs (LP/NG)
- Includes burner, glass wind guard, ignition system, and glass gems
- Choose between liquid propane (WV-56-LP) or natural gas (WV-56-NG)
- Comes standard with direct spark ignition (DSI)
- UL and ULC listed
- Made in USA with US and imported parts

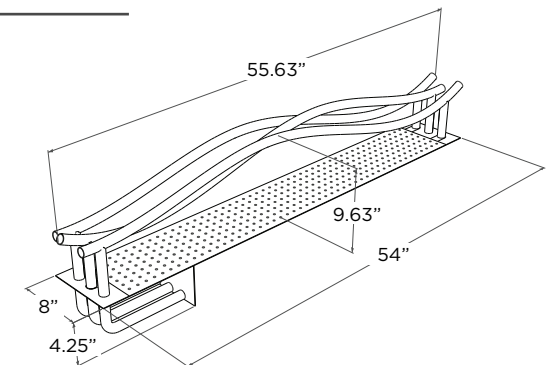



| REFERENCES

# Accessory Glossary

## Rectangular Accessories



**Glass Wind Guard**

● GLASS GUARD-1224

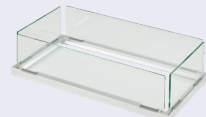

**Folding Wind Guard**

● FWG-1224

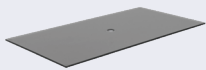

**Grey Glass Cover**

● 1224-GREY-GLASS-COVER



**Protective Cover**

■ SKU listed with product.



**ALC-1224**

● ● ●

■ CVR5038



**KW-1224-19-K**

● ● ●

■ CVR5132



**BRK-1224-19-K**

● ● ●

■ CVR5132



**KN-1224**

● ● ●

■ CVR275715



**PROV-1224-SS**

● ● ●

■ CVR3727



**DAR-1224-EBG-K**

● ● ●

■ CVR4634



**DAR-1224-K**

● ● ●

■ CVR4634



**HVDG-1224-K**

● ● ●

■ CVR4634



**HVGW-1224-K**

● ● ●

■ CVR4634



**HVDG-1224-K**

● ● ●

■ CVR4634



**HVDW-1224-K**

● ● ●

■ CVR4634



**MG-1242-BLSM-K**

● ● ● ●

■ CVR6332



**UPT-1242**

● ● ● ●

■ CVR6549



**UPT-1242-IRO**

● ● ● ●

■ CVR6549



**CR-1242-K**

● ● ● ●

■ CVR6332



**DENBR-1242**

● ● ● ●

■ CVR6332



**KL-1242-MM**

● ● ● ●

■ CVR5427



**KL-1242-SS**

● ● ● ●

■ CVR5020



**KW-1242-K**

● ● ● ●

■ CVR8355



**MCR-1242-BLK-K**

● ● ● ●

■ CVR6332



**CV-54**

● ● ●

■ CVR275715



**CV-54MM**

● ● ●

■ CVR275715



**CV-54WT**

● ● ●

■ CVR275715



**CV-72WT**

■ ■



**CV-72**

■ ■



**CV-72MM**

■ ■

## Linear Accessories



**Glass Wind Guard**

● GLASS GUARD-1242

■ GLASS GUARD-1264

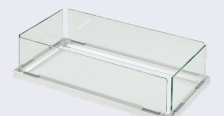

**Folding Wind Guard**

● FWG-1242

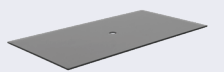

**Grey Glass Cover**

● 1242-GREY-GLASS-COVER



**Stainless Steel Cover**

● SS1242BC

■ SS1264BC



**Protective Cover**

■ SKU listed with product.

**Customize your look.**

Learn more about accessories on page 23.

Round Accessories



Glass Wind Guard

- GLASS GUARD-20-R
- GLASS GUARD-30-R



Grey Glass Cover

- 20-R-GGC
- 30-R-GGC



Ceramic Log Set

- CF20-LOG SET



Black Glass Cover

- CFT-GLASS



Lazy Susan Ring

- LAZY SUSAN RING



Protective Cover

- SKU listed with product.



SF-32-K

- CVR36



SF-32-GRY-K

- CVR36



ED-20

- CVR42



BRON5151-K

- 



CV-2424

- CVR3939



SIERRA-2424-M-K

- CVR4444



BC-20-MNB

- CVR50



BC-20-WO

- CVR50



BRON52-K

- CVR55



CV-20

- CVR36



CV-30WT

- CVR42



CV-30MM

- CVR42



CV-30

- CVR42



CV-30EMM

- CVR42



CV-30EWHT

- CVR42



CV-30E

- CVR42

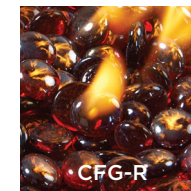
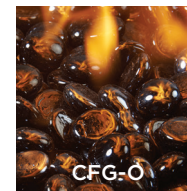
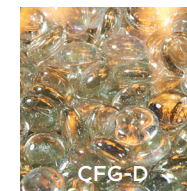
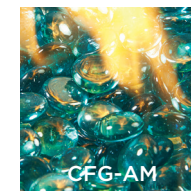
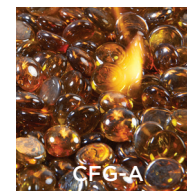

Finish your fire.

Square Accessories



Glass Wind Guard

- GLASS GUARD-2424

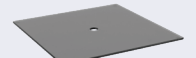

Grey Glass Cover

- 2424-GREY-GLASS-COVER



Ceramic Log Set

- CF20-LOG SET



Protective Cover

- SKU listed with product.

# Standard Materials



## Tempered Glass

Tempered glass is used for all glass wind guards, burner covers, and fire glass. It has been heat-treated and is safe to use with our Crystal Fire® Plus burners. Untempered glass or glass that has not been heat-treated can explode when it reaches high temperatures and is not safe to use with gas fire pit tables.

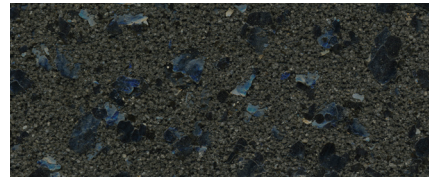

## Stucco

Stucco is used on many of our outdoor products and comes in many colors and finishes. Stucco is a low-maintenance and durable outdoor finish.



## Supercast™ Concrete

Supercast is a proprietary blend of fiberglass and concrete to provide durability and strength. It is stronger and weighs less than traditional concrete. We have a variety of standard colors and finish looks. Custom options available.



## Everblend™ Concrete

Everblend is a process and material developed in-house and manufactured exclusively at The Outdoor GreatRoom Company. It is a weatherproof, concrete finish over a fiber cement and steel structure. The durability can be compared to any glass fiber reinforced concrete but is lightweight for easier handling and installation.



## Wood

Appearance-grade, high-quality wood is used to create your dream design. Multiple stain options are available. Use wood to accent your look or complete your entire design.



## Stainless Steel

Crystal Fire® Plus burners, outdoor kitchen accessories, and finish trims are made from #304 stainless steel. #304 stainless steel is a high quality, commercial-grade metal with superior corrosion and rust resistance.

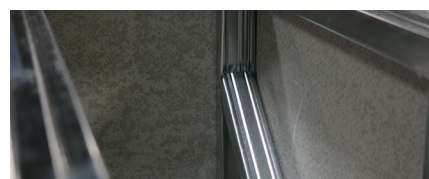

## Steel Framing

Steel framing is used to build many of our gas fire pit tables, outdoor fireplaces, and custom outdoor kitchens. The framing is G90 galvanized steel which provides strong corrosion and rust resistance in most applications.

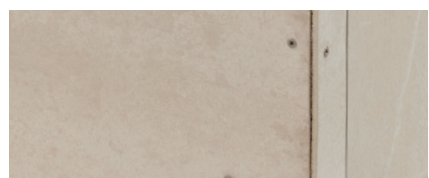

## Fiberock®

Fiberock backerboard is water, mold, and mildew resistant, making it durable for our fire pit tables, outdoor fireplaces and custom outdoor kitchens. This eco-friendly board is made from 97% recycled materials and is ready for stone, tile or other finishing materials because it is solvent, adhesive and resin free.



## Rip-Stop Polyester

Polyester is used for all of the tan protective covers. The fabric provides one-way breathability: keeping exterior water away yet allowing interior moisture out. The covers feature tear-resistant, rip-stop laminating to further reinforce its strength and protection for the outdoors.

# CUSTOM GAS FIRE PIT TABLE REQUEST FORM

Customer Name \_\_\_\_\_ Dealer Name \_\_\_\_\_ Date \_\_\_\_\_

<b>Base Options</b> <input type="checkbox"/> Supercast™ <input type="checkbox"/> Ready To Finish	<b>Round</b> 	<b>Square</b> 	<b>Linear</b> 
<b>Top Options</b> <input type="checkbox"/> Supercast™			

## Material Options

Finish on your own (Fiberock® backerboard and steel framing)

### Top Material | Supercast™ Concrete

\*Standard top height/depth for Supercast™ is 1"

<b>Smooth</b>						<b>Marbleized</b>			<b>Wood Grain</b>	
Deep Black	Midnight Mist	Mocha	Natural Grey	Linen	White	Marbleized Mocha	Marbleized Noche	White Onyx	Antique Timber	Washed Cedar

### Base Material | Stucco

						<b>Metal</b>				
Black Fleck	Midnight Storm	Napa Valley	Ridge Brown	Serengeti	Stony Creek					
						Dora Brown	Graphite Grey	Luverne Black	Pewter Crater	White

\*Colors may not be exact, but are a close representation

## Burner Options

<b>Shape   Linear</b> <input type="checkbox"/> CFP1224-K <input type="checkbox"/> CFP1242-K <input type="checkbox"/> CFP1264 <input type="checkbox"/> CFP1272 <input type="checkbox"/> CFP1284 <input type="checkbox"/> CFP1296 <input type="checkbox"/> CFP12108 <input type="checkbox"/> CFP12120	<input type="checkbox"/> BP1224-A <input type="checkbox"/> BP1236-A <input type="checkbox"/> BP1242-A <input type="checkbox"/> BP1260-A <input type="checkbox"/> BP1264-A <input type="checkbox"/> BP1272-A <input type="checkbox"/> BP1284-A <input type="checkbox"/> BP1296-A <input type="checkbox"/> BP12108-A <input type="checkbox"/> BP12120-A	<b>Square</b> <input type="checkbox"/> CFP2424-K <input type="checkbox"/> BP24S-A <input type="checkbox"/> BP30S-A <input type="checkbox"/> BP36S-A <input type="checkbox"/> BP42S-A	<b>Round</b> <input type="checkbox"/> CFP20-K <input type="checkbox"/> CFP30-K <input type="checkbox"/> BP20RD-A <input type="checkbox"/> BP24RD-A <input type="checkbox"/> BP30RD-A <input type="checkbox"/> BP36RD-A <input type="checkbox"/> BP42RD-A <input type="checkbox"/> BP48RD-A	<b>Ignition System</b> <input type="checkbox"/> Manual ignition (VCSV) <input type="checkbox"/> Direct spark ignition (DSI)	<b>Accessories</b> <input type="checkbox"/> Glass guard <input type="checkbox"/> Glass cover <input type="checkbox"/> Supercast cover <input type="checkbox"/> Stainless steel cover
<b>Fuel Type</b> <input type="checkbox"/> Natural gas <input type="checkbox"/> Liquid propane (Specify hard-pipe or tank: _____) <input type="checkbox"/> LP tank access door					
<input type="checkbox"/> <b>Custom</b> Custom length or shape (Specify: _____)					

Submit completed form to [sales@outdoorrooms.com](mailto:sales@outdoorrooms.com).



# CUSTOM OUTDOOR KITCHEN REQUEST FORM

Customer Name \_\_\_\_\_ Dealer Name \_\_\_\_\_ Date \_\_\_\_\_

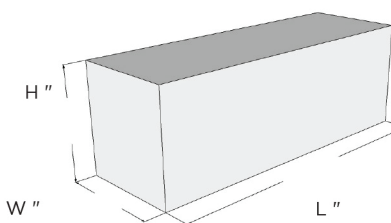
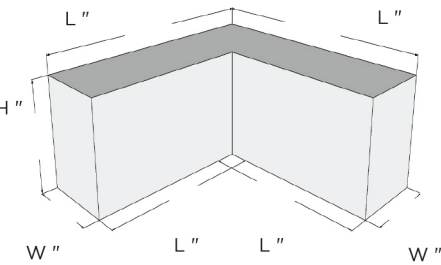
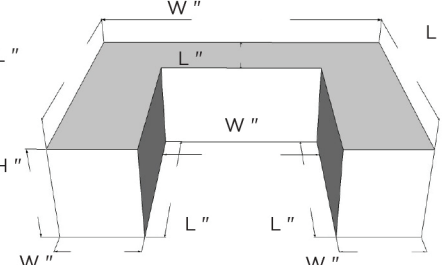
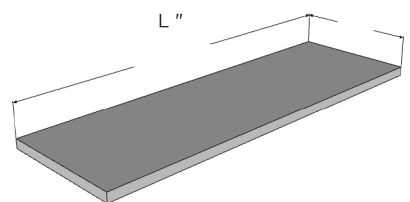
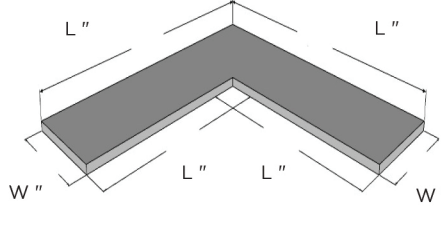
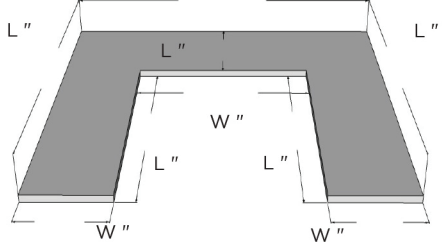





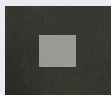
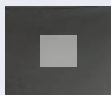

<b>Base Options</b> <input type="checkbox"/> Ready To Finish 	<b>I Shape</b> 	<b>L Shape</b> 
<b>Top Options</b> <input type="checkbox"/> Ready To Finish 		

**Outdoor Kitchen Style**

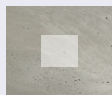



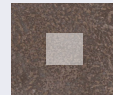
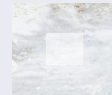
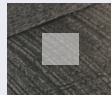



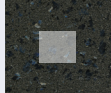

Flat counter  
  Backsplash (no back bar)  
  Countertop overhang ( \_\_\_\_\_ ")  
  Elevated back bar (standard 12" overhang)

**Material Options**  Finish on your own (Fiberock® backerboard and steel framing)

**Top Material | Supercast™ Concrete**  
 \*Standard top height/depth for Supercast™ is 1"

<b>Smooth</b>  Deep Black  Midnight Mist  Mocha  Natural Grey  Linen  White	<b>Marbleized</b>  Marbleized Mocha  Marbleized Noche  White Onyx	<b>Wood Grain</b>  Antique Timber  Washed Cedar
--	--	---

**Base Material | Stucco**

 Black Fleck  Midnight Storm  Napa Valley  Ridge Brown  Serengeti  Stony Creek	<b>Metal</b>  Dora Brown  Graphite Grey  Luverne Black  Pewter Crater  White
--	---

\*Colors may not be exact, but are a close representation

**Accessory Options**

<b>Storage</b> <input type="checkbox"/> 16DRW2 <input type="checkbox"/> 21SNGL-V <input type="checkbox"/> 16DRW3 <input type="checkbox"/> 25ICEBIN <input type="checkbox"/> 30DRW1 <input type="checkbox"/> 28SNGL-H <input type="checkbox"/> 32DDDC <input type="checkbox"/> 20TRO <input type="checkbox"/> 30ICEINS <input type="checkbox"/> DAR044A5BSLDD <input type="checkbox"/> 32DRYSTO <input type="checkbox"/> 25DAD <input type="checkbox"/> 32DAD	<b>Additional Features</b> <input type="checkbox"/> Grill (Brand: _____, Model: _____, Cut-out dimensions: _____) <input type="checkbox"/> Crystal Fire® Plus burner (SKU: _____) <input type="checkbox"/> Sink <input type="checkbox"/> Umbrella hole <input type="checkbox"/> Paper tower holder <input type="checkbox"/> Outlets(s) (Qty: _____) <input type="checkbox"/> Fiberock® backerboard island floor <input type="checkbox"/> Enclose accessory cutouts with Fiberock <input type="checkbox"/> Other (Specify: _____)
--	---

Submit completed form to [sales@outdoorrooms.com](mailto:sales@outdoorrooms.com).

# CUSTOM OUTDOOR FIREPLACE REQUEST FORM

Customer Name \_\_\_\_\_ Dealer Name \_\_\_\_\_ Date \_\_\_\_\_

**Specifications**  
 Finish on site — structure constructed of outdoor-rated cement boarding and steel framing.

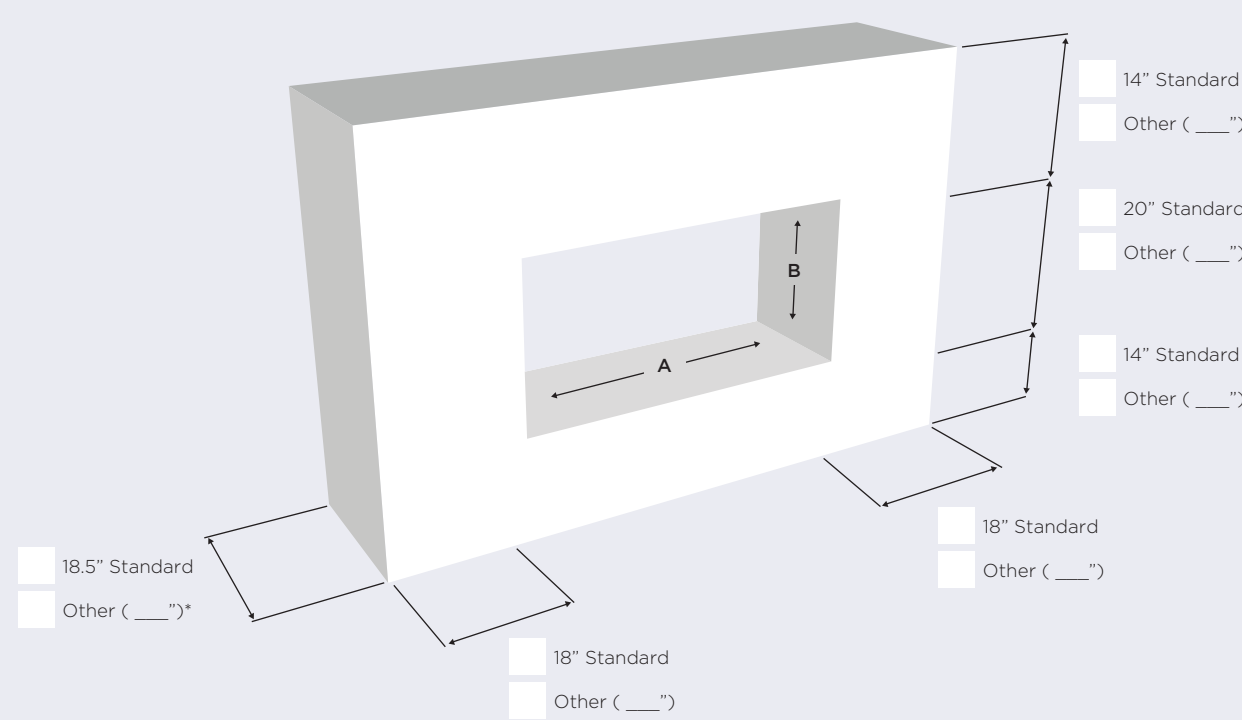

14" Standard  
 Other ( \_\_\_\_\_ ")

20" Standard  
 Other ( \_\_\_\_\_ ")

14" Standard  
 Other ( \_\_\_\_\_ ")

18.5" Standard  
 Other ( \_\_\_\_\_ )"

18" Standard  
 Other ( \_\_\_\_\_ ")

18" Standard  
 Other ( \_\_\_\_\_ ")

**Firebox Opening (A x B)\***

<input type="checkbox"/> 40" L x 20" H	<input type="checkbox"/> 60" L x 20" H	<input type="checkbox"/> 72" L x 20" H	<input type="checkbox"/> 84" L x 20" H
<input type="checkbox"/> 96" L x 20" H	<input type="checkbox"/> 108" L x 20" H	<input type="checkbox"/> 120" L x 20" H	<input type="checkbox"/> Other ( _____" L x _____" H)

<b>Style</b> <input type="checkbox"/> See-through <input type="checkbox"/> Single-sided	<b>Fuel Type</b> <input type="checkbox"/> Liquid propane <input type="checkbox"/> Natural gas	<b>Ignition System</b> <input type="checkbox"/> Manual ignition (VCSV) <input type="checkbox"/> Direct spark ignition (DSI)	<b>Fire Media</b> <input type="checkbox"/> LAV-TMB <input type="checkbox"/> LAVA-BLK <input type="checkbox"/> CFG-D <input type="checkbox"/> CFG-O <input type="checkbox"/> CFG-R <input type="checkbox"/> CFG-A <input type="checkbox"/> CFLD-B <input type="checkbox"/> CFLD-C
---	---	---	--

**Special Notes**

\*Selecting standard dimensions (when applicable) will provide the most cost-effective approach for custom project.

Submit completed form to [sales@outdoorrooms.com](mailto:sales@outdoorrooms.com).

# CUSTOM ACCESSORIES REQUEST FORM

Customer Name \_\_\_\_\_ Dealer Name \_\_\_\_\_ Date \_\_\_\_\_

## Glass Wind Guard

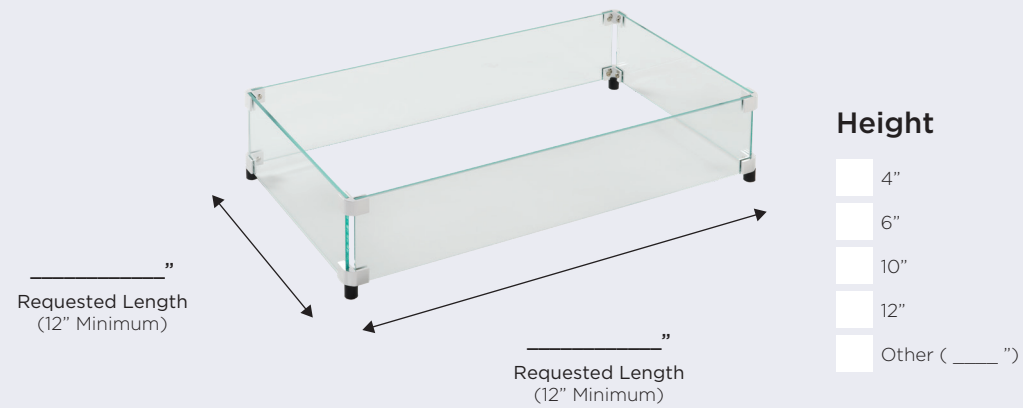

## Tempered Glass Cover

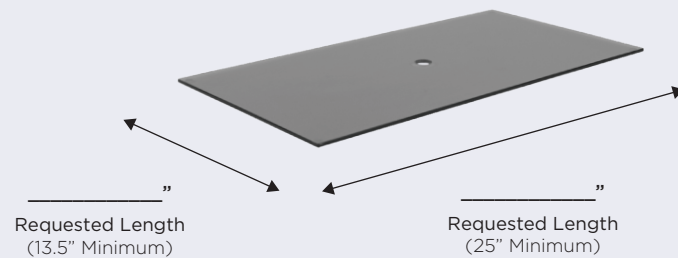

## Stainless Steel Burner Cover



Submit completed form to [sales@outdoorrooms.com](mailto:sales@outdoorrooms.com).

# Warranty

See user manual for more information.

PRODUCT CATEGORY	WARRANTY INFORMATION
<b>Gas Fire Pit Tables and Crystal Fire® Plus Burners</b>	<ul style="list-style-type: none"> <li>Limited lifetime warranty on all stainless steel burners installed in a residential setting, and five years on all stainless steel burners installed in a commercial setting.</li> <li>One year finish warranty</li> <li>One year warranty on ignition &amp; electronics</li> <li>Three year structural warranty on all fire pit bases and top</li> </ul>
<b>Outdoor Gas Fireplaces</b>	<ul style="list-style-type: none"> <li>Limited lifetime warranty on all stainless steel burners installed in a residential setting, and five years on all stainless steel burners installed in a commercial setting.</li> <li>One year finish warranty</li> <li>One year warranty on ignition &amp; electronics</li> <li>Three year structural warranty on all fire pit bases and top</li> </ul>
<b>Outdoor Furniture</b>	<ul style="list-style-type: none"> <li>Three year warranty on framework</li> <li>Five year warranty on Sunbrella® cushions</li> </ul>
<b>Outdoor Kitchens</b>	<ul style="list-style-type: none"> <li>Silicone grout sealant must be applied once per year to any exposed grout</li> <li>One year parts and labor warranty on refrigerator and compressor</li> <li>5 year structural warranty on bases and tops</li> </ul>
<b>Accessories</b>	<ul style="list-style-type: none"> <li>One year warranty on protective covers</li> <li>90-day warranty on glass wind guards</li> <li>Limited lifetime warranty on stainless steel glass wind guard brackets</li> </ul>
<b>Supercast™ Concrete</b>	<ul style="list-style-type: none"> <li>One year structural and finish warranty</li> <li>Non-structural hairline cracks are possible, and shall not be considered a manufacturing defect.</li> </ul>

# Frequently Asked Questions

## Crystal Fire® Plus Burners and Gas Fire Pit Tables

### Are these burners and fire pits UL listed? What does that mean?

Yes, all of our burners are UL and ULC tested and listed. This means they have passed numerous tests to ensure safe operation meet current ANSI standards. They have undergone extensive wind, rain, and clearance tests.

### Can I roast marshmallows over my fire table or burner?

Yes you can; however, this appliance is UL listed as a decorative gas appliance, not a cooking appliance. Make sure that combustible items do not end up in the burner, as it will clog the burner ports and prevent proper operation.

### Are there different Crystal Fire® Plus burner models?

We have 22+ different Crystal Fire® Plus burners and burner kits in stock. All of these can be purchased as one complete unit or individual components. Custom burners are also available. See pages 41-47 for our offering of burners, sizes, controls, etc.

### What type of fuel can I use?

You can choose from either Liquid Propane (LP), or Natural Gas (NG). Most Crystal Fire® Plus burners and stocked fire tables come set-up for LP; however, a NG conversion kit included with each unit. If converting to NG, a certified gas technician should do the installation. When ordering an electronic ignition burner, you must specify LP or NG.

### Can commercial burners be used in residential applications?

Yes, many homeowners desire an electronic ignition burner system as it allows them to control the burner at a switch away from the burner, as well as use optional upgrades like remote controls.

### How many BTUs per hour are produced?

The BTU rating for each burner varies by size and fuel type. For exact BTU ratings, consult the burner manual.

### Can I use my OGC fire table on a wood deck?

Yes, all OGC fire pits & fire tables are okay to use on a wood deck if clearances are met. Crystal Fire® Plus burners are UL and ULC tested and listed and are used in all of our outdoor fire pits. They are okay to use on concrete patios, wood decks, composite decks, etc.

### What regular maintenance should be performed?

Regularly covering and cleaning your Crystal Fire® Plus burner will extend the life of the product and keep it performing at its best. Clean all loose debris, check fittings and tighten if necessary, ensure all gas lines are intact and free from obstructions, replace batteries in sparker if needed. Consult your manual for more information.

### Can I operate my fire table with a smart device?

Yes, we offer a Bluetooth® smart app option for our direct spark ignition system. You may interface your automated home system with our electronic ignition burners too. Contact OGC for more details.

### Is media included with the burners or fire tables?

Yes, we include clear tempered fire glass gems with each Crystal Fire® Plus burner unless otherwise noted. Various lava rock, crushed glass, and colored glass are also available.

### If I purchase a burner for my own project, what else is needed?

That depends on the project and can vary from additional controls, media, etc. You will need to specify the fuel source (LP or NG) used if it is a commercial or custom burner. We recommend working with your local OGC dealer to determine what is needed for your project. You may also contact us at sales@outdoorrooms.com.

### What happens to my burner or fire table when it rains?

If the burner or fire table is uncovered, water will drain through the perimeter of the burner pan. Water will not drain through the burner neck or build up in the burner — it will safely drain out the bottom of the fire table. All fire tables and burners are constructed of outdoor-rated, durable materials.

### Do I need to cover my fire table when not in use?

It is not mandatory to cover the fire table, but is recommended. Our tables are constructed of materials made to withstand outdoor exposure; however, we do recommend covering if not using for extended periods. This will prevent any unwanted debris from falling onto the burner. There are optional protective covers available.

### What is the difference between a commercial burner and a residential burner?

Commercial-rated burners are often required for commercial applications (hotels, restaurants, etc.). The OGC commercial burners are identical to the residential burners except they include electronic ignition (DSI), and emergency shut off switch, and need to be ordered specifically for NG or LP. In addition, they have more options available for controls either at the burner or away from the burner.

For more troubleshooting materials, visit [www.outdoorrooms.com/product-support](http://www.outdoorrooms.com/product-support)

## Custom Outdoor Kitchens

### What is the design and ordering process?

Start by completing the custom outdoor kitchen request form from either our catalog or website. From here, we will communicate throughout the process on pricing and revisions. The entire process can be completed in six weeks once everything is approved. Custom forms are available at [www.outdoorrooms.com/custom](http://www.outdoorrooms.com/custom).

### What type of grills can be built in?

Any grill that has the appropriate installation kit or specifications can be used. This includes gas, charcoal, wood, and pellet.

### Can I order a custom finish to match my home?

Yes, you can also order the unit unfinished and have it finished on-site to match your house and landscape by your local dealer, contractor, or landscaper.

### What are the outdoor kitchens built from?

The structure begins with G90 (marine grade) galvanized steel framing. It is then wrapped in Fiberock® backerboard. From there it can be finished from a variety of materials, or left unfinished to be completed on-site.

## Outdoor Fireplaces

### Are additional sizes available for ready-to-finish fireplaces?

We offer the ability to make custom fireplaces to your specifications. It is most cost-economical to keep the firebox and burner dimensions standard and change the structure dimensions. If you desire a different size firebox, we likely have the ability to provide you with a solution.

### Can I burn wood in any of these fireplaces?

No. These units are not wood-burning fireplaces. The benefits of a gas fireplace include a smoke-free experience, turn on instantly, and provide instant heat.

### Can I run a ready-to-finish fireplace on a standard LP tank?

A standard 20 lb liquid propane tank is only available for use with the 40" model. Other models will burn through gas too frequently.

### Is the fire pit or fireplace approved for use in screened porches, covered porches, gazebos, or lanais?

While the unit itself is not UL approved for this application, there should not be any problem provided the following guidelines are followed:

- A minimum of three walls are screened. Screens must be permanently open. They cannot have windows that can close.
- The screened walls must provide a minimum open area of 30%.
- All appliance ceiling and wall clearances must be met.
- Minimum porch area 96 square feet.

## Furniture

### How do I clean the fabric?

Most stains can be cleaned with mild soap and warm water. Blot the affected area and try to remove the stain with the cleaning mixture. For more detailed instructions, please visit [www.sunbrella.com](http://www.sunbrella.com).

### Do I need to store my cushions from the rain and/or winter?

The furniture is built to withstand a variety of weather conditions. You can choose to store them inside if you prefer that they are clean and dry to use.

### Is the furniture rust-resistant?

Yes, due to the complete powder-coating process on the frames.

For more troubleshooting materials, visit [www.outdoorrooms.com/product-support](http://www.outdoorrooms.com/product-support)



 the outdoor  
greatroom  
company



### Address

9583 217th St W Suite 100  
Lakeville, MN 55044

### Phone

Direct: (952) 658-6730  
Toll Free: 1 (866) 303-4028  
Fax: (952) 658-6731

### Email

Sales and Support: [sales@outdoorrooms.com](mailto:sales@outdoorrooms.com)  
Customer Service and Orders: [orders@outdoorrooms.com](mailto:orders@outdoorrooms.com)  
Marketing: [marketing@outdoorrooms.com](mailto:marketing@outdoorrooms.com)

### Website

[outdoorrooms.com](http://outdoorrooms.com)

Information as of November 2022. Subject to change.





the **outdoor**  
**greatroom**  
company



[outdoorrooms.com](http://outdoorrooms.com)

THE OUTDOOR GREATROOM COMPANY

2023 CATALOG

BRING HOME OUTSIDE®

